



TECHNOLOGIJOS RENGINIAMS

PLANAVIMAS INŽINERIJA ĮGYVENDINIMAS

EVENT TECHNOLOGY

CONCEPT ENGINEERING REALISATION

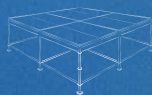

STAGING



RIGGING



LIGHTING



SOUND



VIDEO







Kaip išsinuomoti įrangą?

1. Susisiekite su mumis.
El. paštu: info@prodj.lt
Tel: +370 608 00808

arba užpildykite formą www.prodj.lt

2. Išsirinkite įrangą, nurodykite nuomos terminą bei įrangos naudojimo vietą. Jei nežinote, kokios tiksliai įrangos reikia, atsiųskite renginio programą ir grupių ar atlikėjų Jums keliamų techninių reikalavimų sąrašus.

3. Jei reikalingi technikai įrangos montavimui/demontavimui ar aptarnavimui renginio metu, informuokite mus pateikdami užsakymą.
4. Susipažinkite su bendrosiomis įrangos naudojimo sąlygomis, kurias rasite šio leidinio 90-ame puslapyje ir ProDJ internetinėje svetainėje www.prodj.lt.
5. Pasirašykite sutartį su ProDJ.
6. Atlikite apmokėjimą sutartyje numatytais sąlygomis ir terminais.
3. If you are in need of technicians for mantling/dismantling or for any service during the event, inform us when you fill the form or when you make the order.
4. Read our General Terms and Conditions of the Rental Equipment and Service Provision that are at page 91 of this publication as well as on our website www.prodj.lt
5. Sign the contract with ProDJ.
6. Make the payment according to the contract (its terms and conditions).

Turinys / Table of contents



Projektų rengimas / Project development **7**

Techninių reikalavimų įgyvendinimas /
Implementation of Riders

Techninių sąlygų konkursams ruošimas /
Preparation of Technical Terms and Conditions for Contests

Brėžnių parengimas / Plans

Apkrovų apskaičiavimas / Calculation of Loads

Vizualizavimas / Visualisation

Kabinamos įrangos plano paruošimas /
Preparation of a Plan for Rigging Equipment

Įgarsinimo ir ryšio įranga / Audio and Communication **13**

Procesoriai ir ekvalizeriai / Processors and EQs

Efektai ir intarpai / FX and Inserts

Silpnų srovių kabeliai, multikabeliai / Cables

Skaitmeniniai garso pultai / Digital Mixing Consoles

Analoginiai garso pultai / Analog Mixing Consoles

Komplektai / FOH - PA Sets



Apšvietimas / Lighting **33**

ELATION / ELATION

Judantys prožektoriai / Moving Lights

Tradiciniai prožektoriai / Conventional Lights

Bendra įranga / General Equipment

Priedai / Accessories

Dūmų ir rūko mašinos, ventiliatoriai, CO₂ ir konfeti patrankos /
Smoke and Haze Machines, Fans and CO₂ Confetti Cannons

Elektrios tiekimas / Power supply

47

Kabėliai / Cables

Kabėlių apsaugos / Cable Ramps

Galios paskirstymas / Power Distribution

Generatoriai / Generators



Santvaros ir pakabinimo konstrukcijos / Truss & Rigging

57

Elektriniai/rankiniai įrangos keltuvai / Electrical/Manual Hoists

Pakylės / Staging

Kabinamos įrangos priedai / Rigging Accessories

Stovai ir kiti reikmenys / Stands and Accessories

Santvaros / Trusses

Vaizdo įranga / Video

75

Šviesos diodų ekranai / LED Screens

Monitoriai / Displays

Projektoriai / Projectors

Procesoriai / Processors

Keitikliai / Converters

Kabėliai / Cables



Logistika / Logistics

83

Vilkikai / Trucks

Furgonai / Vans

Mikroautobusai / Minibuses

Vadovas / CEO

Dovydas Bajoras



Jau išleidžiama mūsų trečioji „ProDJ knygutė“ – tokį paprastą pavadinimą šiam leidiniui davėte Jūs, mūsų klientai. Iš Jūsų gavome daug teigiamų atsiliepimų ir pasiūlymų, kaip dar ją galėtume patobulinti. Ačiū Jums už tai, kad įvertinote mūsų darbą ir pastangas.

Pirmąjį šios knygutės numerį išleidome turėdami tikslą, kad renginių organizatoriai geriau ir greičiau rastų bendrą kalbą su bendrovėmis, užsiimančiomis įrangos nuoma renginiams. Panašu, kad mums tai pavyko. Jūs greičiau galėjote palyginti įrangos nuomos kainas, aiškiai suvokti, kokias nuolaidas galima gauti įrangai, kai ji nuomojama ne venai dienai, o visam savaitgaliui ar net kelioms savaitėms. Neapklusinėjant transporto kompanijų, kurios užsiima pervežimais, ši knygutė padeda preliminariai, bet gan tiksliai įvertinti logistikos kaštus. Leidinys tapo geru pagalbininku daugeliui renginių organizatorių, kurie dalyvauja dideliuose konkursuose, daugeliui viešuosius pirkimus skelbiančių įstaigų specialistų, kurie rengia medžiagą konkursams. Pirmiausia Jūs bandote atsakyti į klausimą **O KIEK DAUGMAŽ TAI KAINUOJA?** „ProDJ knygutė“ greitai atsako į šiuos klausimus:

1. Kiek kainuoja įrangos nuoma?
2. Kiek kainuoja montžas / demontažas ir aptarnavimas renginio metu?
3. Kiek kainuoja transportavimas?

Atsižvelgdami į Jūsų pageidavimus ir lūkesčius šį knygutės numerį keičiame taip, kad matytųsi ir tendencijos. Išėmė nepopuliarią ir retai renginiuose naudojamą įrangą, palikome tai, kas yra laiko patikrinta ir su kuo bus galima dar ne vienerius metus patikimai aptarnauti renginius. Taip pat atnaujino me ir savo (portfolio). Žvelgiant į ateities perspektyvą, mes ir toliau stiprinsime savo projekta-vo padalinį ir kitose knygutėse pristatysime vis daugiau unikalių projektų, scenos dizaino idėjų. Stengiamės daryti Jums kuo patogesnę ir prieinamesnę įrangos nuomos tiesiai iš sandėlio sistemą.

The third “ProDJ booklet” will be published soon. Such a simple name of this publication was created by you, our dearest customers. During this time, we received many positive feedbacks and suggestions on how to improve it further. Thank you for appreciating our work and efforts. We published the first volume of this booklet in order to improve communication between event organisers and companies that were involved in the rental business of equipment used during various events. It seems that we have achieved this goal. Therefore, you may compare prices of rental equipment faster and clearly understand what discounts you may get for an equipment, when it is rented not for one day, but for the entire weekend or even for several weeks. This booklet will also help you to assess the costs of logistics quite accurately without contacting any transport companies. Moreover, this publication has become a good assistant for many event organisers, who participate in large-scale tendering procedures, as well as many specialists of various institutions, announcing public procurements and preparing the material for the tendering procedures. The first question you want to be answered is: “HOW MUCH COULD IT COST?” The “ProDJ booklet” will immediately answer you the following questions:

1. How much does the rental equipment cost?
2. What is the price of assembly, disassembly and service of such equipment during the event?
3. How much does the transportation cost?

Based on your preferences and expectations, we changed this volume so that you could also see the most popular trends. We removed the unpopular equipment, which was rarely used in the events and kept a time-proven equipment, which will reliably serve you during the events for many years to come. Finally, we also updated our portfolio. Looking forward, we will continue to strengthen our design unit and will introduce you many more unique projects and stage design ideas in the following booklets. We aim to create as comfortable system of available rental equipment, taken directly from our warehouse, as possible.



MISIJA

Bet kurį renginį aprūpinti reikia įranga ir suteikti profesionalų aptarnavimą.

VIZIJA

Tapti stipriausia bendrove Rytų ir Vidurio Europoje, užsiimčia trumpalaikę įrangos nuoma.

TIKSLAS

Gauti didžiausią įmanomą ekonominę naudą iš vykdomos veiklos.

PRIEMONĖS TIKSLUI PASIEKTI

- Rentabilios investicijos į moderniausias įrangą, skirtą renginių aptarnavimui
- Nuolatinis darbuotojų kvalifikacijos kėlimas ir naujų darbo vietų kūrimas

MŪSŲ VERTYBĖS

Profesionalumas ateina su patirtimi. Klientų bei kolegų pagarbą užsitarnavome savo paslaugas teikdami atsakingai. Profesionalumą darbe rodo gera komanda, kokybiška technika ir teigiami klientų atsiliepimai.

Lankstumas ir operatyvumas leidžia komandai individualiai reaguoti į konkrečią kliento situaciją. Atsižvelgę į kliento poreikius bei interesus ir savo technines galimybes - greitai ir lanksčiai priimame geriausių sprendimų.

Renginio kokybė yra kuriama protingai planuojant, gerai organizuojant, tiksliai įgyvendinant ir laiku kontroliuojant. Kvalifikuoti darbuotojai ir specializuota technika leidžia mums siekti aukščiausių renginio kokybės standartų.

Darbuotojų sveikata ir saugus darbas yra pamatinis ProDJ prioritetas. Mūsų komanda nuolat atnaujinama darbo saugos ir sveikatos reikalavimų žinias. Kiekvienas darbuotojas yra apmokomas saugiai dirbti su technine įranga.

Informacijos logistika yra neatsiejama perspektyvus verslo sąlyga. Ypatinę dėmesį skiriame informacijos sklaidai bei darbų paskirstymui, nes tik tada, kai viskas aišku, galima siekti profesionalaus techninio renginių aptarnavimo.

Matomas rezultatas skatina siekti daugiau. Puikus jausmas visą ProDJ komandą užvaldo, kai projektas įgyvendinamas laiku ir be priekaištų, kai renginio dalyviai džiūgaujia, o klientai lieka patenkinti visais renginio įgyvendinimo procesais.

Socialinė atsakomybė yra neatsiejama bendrovės veiklos dalis. ProDJ kas met remia apie 10 sporto ir visuomeninių organizacijų organizuojamų renginių.



OUR MISSION

To provide any kind of event with the right equipment and professional service.

VISION

To become the strongest company within Eastern and Central Europe that provides short-term equipment rental.

GOAL

Get the maximum possible economic benefit from the ongoing service.

MEASURES TO ACHIEVE GOALS

- Cost-effective investments in state-of-the-art equipment that serves events.
- Regular staff training and job creation

WE VALUE

Professionalism

By delivering high quality services, we earn respect and trust of our customers and colleagues. Occupational professionalism is also demonstrated by a good team, high quality technique and positive customer feedbacks.

Flexibility and operational efficiency

We always take into account the specific situation, as well as particular needs and interests of the customers. By combining the customer needs with our abilities, we make the best decision promptly and flexibly.

Quality

We strive for it by using rational planning, good organisation, accurate performance and timely control. Our qualified employees and specialised technologies allow us to achieve the highest quality standards.

Occupational health and safety

"ProDJ" follows the requirements of occupational health and safety. Every employee is trained to work with technical equipment safely.

Information logistics

We pay special attention to dissemination of information and distribution of works because professional technical maintenance services can be provided only when everything is clear.

Visible result

It's a great feeling when the project is completed, event participants feel happy, customers are thankful and "ProDJ" team members congratulate each other for doing another good job.





Projektų rengimas / Project Development

Techninių reikalavimų įgyvendinimas /
Implementation of Riders

Techninių sąlygų konkursams ruošimas /
Preparation of Technical Terms and Conditions for Contests

Brėžinių parengimas /
Plans

Apkrovų apskaičiavimas /
Calculation of Loads

Vizualizavimas /
Visualisation

Kabinamos įrangos plano paruošimas /
Preparation of a Plan for Rigging Equipment



PLANAVIMAS

Geriausi mūsų specialistai dirba kartu su Jumis, kad su-prastų Jūsų renginio tikslus ir atrastų kūrybinį sprendimą, kuris sukurs maksimalų efek-tą. Iš Jūsų idėjos mes sufor-muosime renginio koncepciją, o naudodami 3D programinę įrangą parodysime, kokio vizualaus rezultato galima tikėtis.



CONCEPT

We work together with the best technicians in order to understand the objectives of your event and to find a creative solution that would create the maximum effect. We will form an even concept from your idea and show you what kind of result you can expect by using 3D software.

ENGINEERING

INŽINERIJA

Šiame etape mūsų inžinieriai ne tik tiksliai suskaičiuos, kiek ir kokios įrangos reikia renginio idėjos ir koncepcijos įgyvendinimui, bet ir nurodys, kiek įranga sveria, kur ir kaip turi būti pakabinta/išdėstyta, koks jai numatytas elektros poreikis, kiek laiko reikia jai sumontuoti ir t. t. Čia praktiškai pritaikome mūsų komandos turimas žinias ir patirtį. Suformuojame aiškias užduotis technikams, kurie jas turės tiksliai įgyvendinti pasiruošimo etape ir viso renginio metu. Darbų grafikas turi derėti su renginio programa.



At this stage, our engineers will not only accurately calculate the amount and type of equipment you will need in order to implement a concept and idea of your event, but also indicate its weight, location and position of placement, the estimated demand for electricity, duration of installation and other important information. Here we will apply the knowledge and experience of our team members in practice. In addition, we will formulate clear tasks for our technicians, who will be obliged to implement them accurately during the stage of preparation and the entire period of event. The work schedule must comply with the programme of event.

ĮGYVENDINIMAS

Visi projektų vadovai ir inžinie-riai turi aukštąjį universitetinį savo srities išsilavinimą ir ilgametę darbo patirtį. Ne-gana to, visa komanda nuolat tobulinasi mokymuose, dalyvauja parodose, skiria laiko individualiam įgūdžių lavinimui. Komanda ne tik kvalifikuota, bet ir motyvuota visada neprikaištingai atlikti darbus! Būtent dėl šios savy-bės visus projektus įgyvendiname sklandžiai ir laiku.



REALISATION

All project managers and engi-neers have a higher education in their field of activities, as well as a long-term work ex-perience. Nevertheless, all the team is constantly im-proving their knowledge by participating in trainings, exhibitions and devote their time for individual develop-ment of skills. The team is not only highly qualified, but also motivated to perform their tasks up to the highest standard! Due to this reason, we implement all of our projects in a smooth and timely manner.

Planavimas ir inžinerija / Concept and Engineering

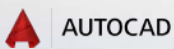
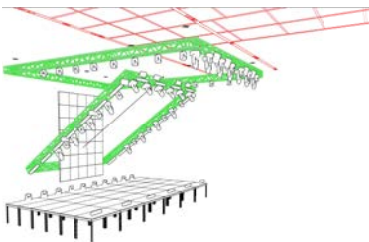
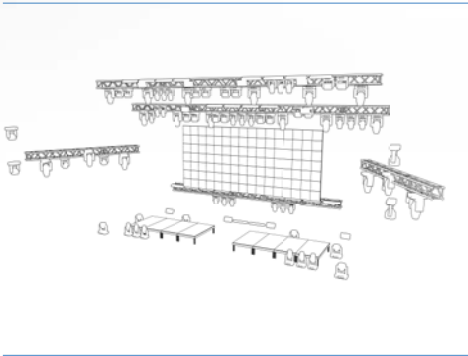
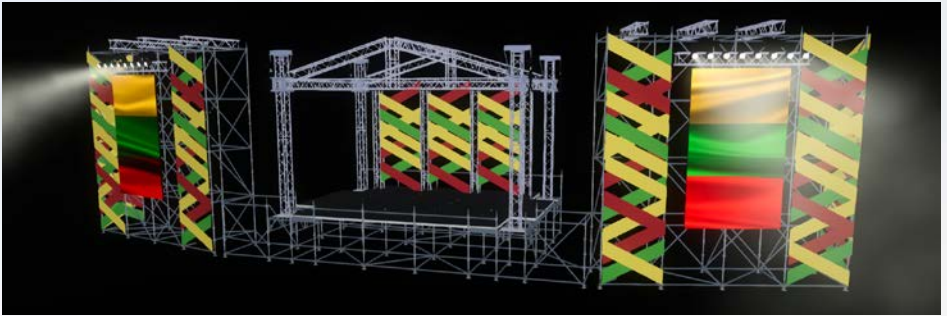

Pagrindinės veiklos / Main activities

„ProDJ“ projektų vadovai žino, kokie aukšti reikalavimai keliami renginių įgarsinimui, apšvietimui, ekranų vaizdo kokybei. Mūsų patyrusi komanda turi reikiamus gebėjimus numatyti poreikius, identifikuoti problemas, tinkamai reaguoti ir laiku jas išspręsti. Todėl galime teikti aukščiausio lygio renginių techninio aptarnavimo paslaugas:

- scenų montavimas ir demontavimas su visa reikalinga garso ir vaizdo aparatūra;
- trumpalaikė įrangos nuoma. Įrangą galima išsinuomoti su pristatymu Jūsų nurodytu adresu arba atsiamti mūsų sandėlyje Klaipėdoje. Taip pat teikiame ir išnuomos įrangos montavimo, demontavimo bei aptarnavimo paslaugą;
- mes konsultuojame renginių organizatorius, pateikiame renginio koncepciją, vizualizacijas (kaip galėtų atrodyti scena, apšvietimas, dekoracijos ir kt. elementai Jūsų renginyje).

„ProDJ“ project managers know the high requirements set for the audio, lighting and video quality of events. Our experienced team has all the necessary skills to estimate the needs, identify problems, properly respond and solve them in a timely manner. Therefore, we can ensure the highest quality of the following technical maintenance services:

- Assembling and disassembling of stages including all the required audio and video equipment;
- Short-term rent of equipment. You can rent equipment with its delivery to your indicated address or collect it at our warehouse in Klaipėda. We also provide assembling, disassembling and maintenance services of rented equipment;
- We consult event managers and provide them a concept and visualisations of event (how the stage, lighting, decorations and other elements will look like at your event).

„ProDJ“ komanda atlieka ir projektavimo užduotis bei konsultuoja iškilus klausimams:

- kokie galingumo elektros įvadų reikės ir kaip juos tinkamai paskirstyti; kokie dydžio ir iš kokių konstrukcijų reikia statyti sceną, kokių gali prireikti pagalbinių konstrukcijų, parengiame brėžinius (AutoCAD);
- kiek ir kokių apšvietimo prietaisų reikia norint tinkamai perteikti renginio idėją, pateikiame montavimo planą. Capture Atlas - Symphonie;
- pagal atskiras renginio erdves parenkame tinkamiausią garso sistemą (SoundVision arba EASE Focus 3), video medžiagą ir pritaikome LED ekranams (Resolume).

„ProDJ“ team performs design tasks and consult, regarding the following matters:

- We prepare drawings (AutoCAD) of the power of electrical inlets and their distribution, the size and types of structures that are necessary to construct a stage, as well as additional structures;
- We provide a design of installation (Capture Atlas - Symphonie) and indicate the necessary amount and type of lights to convey an event idea properly;
- According to the separate areas of event, we select the most suitable audio system (SoundVision or EASE Focus 3) and video material, as well as adapt it to LED screens (Resolume).

Atliekame visus renginiams skirtos įrangos montavimo, demontavimo ir aptarnavimo darbus:

- scenų, pakylų, pastolių ir įvairiausių konstrukcijų montavimas ir demontavimas;
- apšvietimo įrangos montavimo, pajungimo ir programavimo darbai;
- garso aparatūros pakabinimo, pajungimo, suderinimo darbai;
- LED ekranų montavimas, programavimas;
- laikinų elektros įvadų įrengimas;
- aukštaliapių darbai.

We perform assembling, disassembling and provide technical maintenance of the following event equipment:

- Assembling and disassembling of stages, platforms, scaffolds and various structures;
- Installation, connection and programming works of lighting equipment;
- Hanging, connection and tuning of audio equipment;
- Assembling and programming of LED screens;
- Installation of temporary electrical inlets;
- Works at heights.

Mūsų rinka / Our market



FESTIVALIAI, KONCERTAI ARENOSE

ProDJ komanda yra dirbusi visose Baltijos šalių arenose, tad puikiai žino jų akustines savybes, geba spręsti specifines, vienoje ar kitoje vietoje atsirandančias, problemas. Šviesos operatoriai dirba taip, kad salės trūkumus paverstų privalumais. Vieša paslaptis, kad grupės ir atlikėjai savo pasirodymų metu visada stengiasi įpinti šou elementų, kurie žavi publiką.

Norint sėkmingai ir tiksliai juos įgyvendinti, aptarnaujanti komanda turi jausti atlikėjus ir dirbti idealiai, kad maksimaliai sustiprintų publikos pojūčius koncerto metu. Mums nieko nėra maloniau, kai atlikėjai dėkoja už puikų aptarnavimą, o žiūrovai išeidami balsu aptarinėja puikų pasirodymą.



FESTIVALS, ARENA TOURS

ProDJ worked in all big arenas within the Baltic countries, therefore, know all the acoustic characteristics and are able to solve specific arising problems. Lighting operators are keen in turning the halls disadvantages to benefits. It's not a new phenomenon that bands usually try to inweave show elements that fascinate customers.

If you want to successfully achieve your goals, the team should work perfectly and overthink every upcoming step. There is nothing more enjoyable than a big thank you from the band and excellent comments from the audience.

VERSLO RENGINIAI, PARODOS

Jūsų įmonė, organizuodama renginį, reprezentuoja save klientų, partnerių ir savo darbuotojų akivaizdoje. Norint padaryti jiems įspūdį, Jums reikia geriausio rezultato, išskirtinumo, aukščiausio lygio aptarnavimo ir garantijos, kad viskas įvyks sklandžiai. Kai lūkesčiai yra dideli, o laiko mažai, Jūs norite dirbti tik su tiekėju, kuris turi techninę renginių aptarnavimo patirtį.

Kiekvienas renginys yra naujas projektas, kuris turi būti tinkamai valdomas, todėl Jums reikia ProDJ.lt komandos, kuri puikiai žino kas yra dialogas, naudojasi naujausiomis technologijomis ir sugeba rasti geriausių sprendimų.



BUSINESS EVENTS, EXHIBITIONS

Your company, while organizing an event, represents itself in front of customers, partners and also your employees. If you want to make an impression you need to obtain the best result and uniqueness as well as highest service and guarantee level. When the expectations are high and the time limit is low, you only want to work with a supplier who has experience in working with technical event service.

Every event is a new project, that has to be managed in the right way, this is why you need ProDJ.lt team, that knows what is a dialogue, work with new technologies and are keen in finding the best solution.

MIESTO ŠVENTĖS, MUGĖS

Aktyviai bendradarbiaujame su daugeliu šalyje esančių kultūros centrų ir mielai padedame rengti miestų ir miestelių šventes. Viešosiose Lietuvos miestų erdvėse tenka dirbti ir su komerciniais klientais, kuomet jie rengia koncertus, siekdami savireklamos, prekinių ženklų populiarinimo ar kitų tikslų.



TOWN FESTIVALS

We actively cooperate with many national cultural centres and we gladly help to prepare festivals of various cities and towns. Moreover, we are used to work with commercial customers in the public spaces of Lithuanian cities, when they organise concerts in order to advertise themselves, to promote trademarks or for other purposes.

PRIVATŪS RENGINIAI

ProDJ aptarnauja ir privačius renginius, tarp kurių dažniausiai pasitaiko itin prabangios sportininkų ir verslininkų vestuvės.

Mums pažįstamos prabangių restoranų, dvarų, parkų erdvės, dėl to ne tik gerai atliekame savo darbą, bet ir sugebame patarti, kaip išvengti nemalonių staigmenų renginio metu. Nuolat bendradarbiaujame su daugeliu vestuvių ir kitų renginių organizatoriais, suprantame šios srities specifiką.



PRIVATE EVENINGS

"ProDJ" provides services in private events, most of which include the luxurious weddings. We are acknowledged with spaces of luxurious restaurants, manors and parks; therefore, we not only do our work well, but also are able to advice how to avoid unpleasant surprises during the event.

We greatly cooperate with wedding planners or corporate event organisers during the arrangement of the private festivals.



Įgarsinimo ir ryšio įranga / Audio and Communication

Procesoriai ir ekvalaizeriai /
Processors and EQs

Efektai ir intarpai /
FX and Inserts

Silpnų srovių kabeliai, multikabeliai /
Cables

Skaitmeniniai garso pultai /
Digital Mixing Consoles

Analoginiai garso pultai /
Analog Mixing Consoles

Komplektai /
FOH - PA Sets



Klaipėdos Elingą - kruizinių laivų terminalo teritorijoje esančią muzikos ir meno oazę po atviru dangumi - jau keletą vasarų užlieja karšti muzikos ritmai.

Čia vyko įspūdingi Lietuvos muzikos žvaigždžių pasirodymai: Lilas and Innomine, Džordana Butkutė, Beissoul & Einius, Jazzu, Donatas Montvydas, G&G Sindikatas, 8 Kambarys, Mad Money, Leon Somov, Jovani, Jurga, Niko Barisas, Migloko bei Angelou.

Šių koncertų organizatorius techninę dalį patikėjo UAB "ProDJ" komandai.

ProDJ Visas idėjas ir sumanymus įgyvendino su kaupu - pastatyta išskirtinė scena, trijų pakopų VIP pakyla užtikrinanti geriausių koncertų matomumą, paruošti specialūs techniniai sprendimai scenos apšvietimui ir vizualizacijoms LED ekranuose, pasirūpinta ne tik įspūdingu renginio vaizdu bet ir kokybišku koncertų skambesiu.





Klaipėda's Shipyard - an open-air oasis of music and arts situated in the territory of cruise ship terminal - for several summers now has been a place where hot beats of music overflow the quay of Klaipėda.

Spectacular performances with Lithuania's most known music artists, such as: Lilas and Innomine, Dzordana Butkute, Beissoul & Einius, Jazzu, Donatas Montvydas, G&G Sindikatas, 8 Kambarys, Mad Money, Leon Somov, Jovani, Jurga, Niko Barisas, Migloko and Angelou were held in the shipyard. The technical part of these concerts was trusted to the crew of UAB "ProDJ". ProDJ implemented all of the ideas and conceptions over and above - an exclusive stage and a three-step VIP platform, that provided the best visibility of all concerts, was built, technical solutions for lighting and LED screen visualizations were prepared and the best audio equipment was set on stage - that not only ensured a spectacular view but also guaranteed a high quality of sound at the concert.

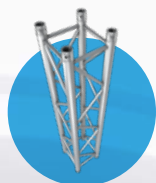

Tvirtinamos ir pastatomos konstrukcijos /
Truss, and Staging Structures

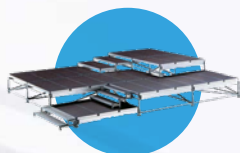

„Baltic Stages“ konstrukcijos /
"Baltic Stages" Structures



Void Stasys x V2



Void garso sistema /
Void Sound System



Chamsys MQ500



SHURE ULXD radio mikrofonai /
SHURE ULXD Wireless microphones



LED šviesos diodų ekranas /
LED display



Elation CUEPIX Panel



Grand MA2



dLive S7000



Konfeti patranka /
Confetti Cannon

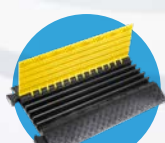

Adam Hall Defender



Elation Platinum Seven

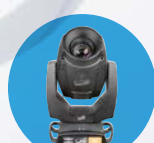

Clay Paky Alpha 1500



Elingas

Garsiakalbiai / Speakers

	Kaina / Price
Outline GTO C-12	85 ⁰⁰ €
Outline DB18-2	60 ⁰⁰ €
L-Acoustics 115XT HiQ	29 ⁰⁰ €
VOID Arcline 12	45 ⁰⁰ €
VOID Stasys X V2	54 ⁰⁰ €
VOID Stasys Xair	74 ⁰⁰ €
dB Technologies Fifty line	185 ⁰⁰ €
dB Technologies LVX M15	60 ⁰⁰ €
Next LA 122WA, 1 vienetai / 1 pics	125 ⁰⁰ €
Next HFA 112s, 2 vienetai / 2 pieces	45 ⁰⁰ €
Next LAs 118A, 2 vienetai / 2 pieces	54 ⁰⁰ €
Next HFA 206a, 2 vienetai / 2 pieces	38 ⁰⁰ €
Next HFA 106a, 2 vienetai / 2 pieces	38 ⁰⁰ €

Kainos nurodytos be PVM / Prices without VAT

Stasys Xair



L-Acoustics 115XT HiQ

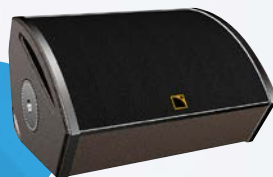

VOID Arcline 12



dbTechnologies LVX XM15



Next LA 122WA



Outline GTO C-12



ABBA
Arrival 2018 12 31
Palanga



Kolonėlių kompleksas / Speaker sets

Pakabinamas garso kolonėlių kompleksas

	999⁰⁰ €
VOID Arcline 12	12 units
Frequency Response 90 Hz - 20 kHz -3dB points	
Efficiency LF 105.0 dB 1w/1m, MF 101.5 dB 1w/1m, HF 108.0 dB 1w/1m	
Crossover Point 250 Hz and 1.8 kHz active	
Impedance LF 8 ohms, MF 8 ohms, HF 5.3 ohms	
Power Handling LF 700 w RMS, MF 900 w RMS, HF 240 w RMS	
Maximum Output 130.5 db cont, 136.5 db peak	
Driver Configuration 1 x 12" neo : 4 x 6.5" neo : 3 x 1" neo	
Dispersion 120° h x 7° v	
Connector 2 x 8 pole Speakon	
VOID Stasys XV2	4 units
Frequency Response 30Hz - 180Hz ±3dB	
Efficiency 103.8dB 1w/1m	
Crossover Point 38Hz Hi Pass 24dB/oct, 100Hz - 145Hz Lo Pass 24dB/oct	
Impedance 4 ohms	
Power Handling 3200 Watts RMS	
Maximum Output 138dB cont, 142dB peak	
Driver Configuration 2 x 18" LF	
Dispersion Array dependent	
Connectors 2 x 4-pole speakON™ NL4	
Height 554mm (21.8")	
Width 1218mm (48") Depth 896mm (35.3")	
Weight 130Kg (286.6lbs)	
Enclosure 18mm birch plywood	
Powersoft AMP rack	2 units
1 x Powersoft K20/ VOID V9	1
Powersoft X8	1
Cisco SG300-10	1
Pealight power distro	1
Cable set	1 unit

Kainos nurodytos be PVM / Prices without VAT



VOID
Arcline 12



VOID
Stasys XV2

Kolonėlių komplektas Nr. 2 / Speaker sets No 2

Pastatomas ar pakabinamas kolonėlių komplektas

	273 ⁰⁰ €
LA122WA - Active 2-Way Compact Wide Line Array	4x
- Coverage Angle -6dB (HxV)	120° x 15°
- High Frequency	2 x 1.4"
- Low Frequency	1 x 12"
LAs118A - Active Hybrid-Horn Arrayable Subwoofer	2x
- Low Frequency	1 x 18"
- Section Power (RMS/Program/Peak) LF	2200W/2960W/5920W

Kainos nurodytos be PVM / Prices without VAT



AMP rack
Nuoma / Rent
350⁰⁰ €

K20 - 1vnt.
Powersoft X8 - 1 vnt.
Patch cable set
Cisco switch SG300-10
32A power distro



Laidiniai mikrofonai / Wired Microphones

	Kaina / Price
AKG C 1000 + clamp + windscreen	6 ⁰⁰ €
AKG C 451 B + clamp + windscreen	8 ⁰⁰ €
AKG C 417 PP + clamp + windscreen	6 ⁰⁰ €
Audio Technica AE3000	9 ⁰⁰ €
SHURE beta 52A	6 ⁰⁰ €
SHURE beta 56A	6 ⁰⁰ €
SHURE beta 57A	6 ⁰⁰ €
SHURE beta 58A	6 ⁰⁰ €
SHURE SM 58	6 ⁰⁰ €
SHURE beta 87A	8 ⁰⁰ €
SHURE SM 57	6 ⁰⁰ €
SHURE SH55 (retro)	15 ⁰⁰ €
SHURE Beta 91	8 ⁰⁰ €
HEIL PR35	6 ⁰⁰ €
Sennheiser e825	6 ⁰⁰ €
Sennheiser e602	6 ⁰⁰ €
Sennheiser e904	6 ⁰⁰ €
DPA d:vote 4099	25 ⁰⁰ €
DPA d:vote Classic Touring Kit 10	207 ⁰⁰ €

Kainos nurodytos be PVM / Prices without VAT



DPA d:vote 4099



DPA d:vote Classic Touring Kit 10



Sennheiser e602



SHURE SH55



SHURE beta 87A

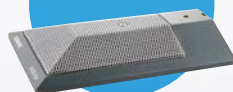

SHURE Beta 91

Bevieliai mikrofonai / Wireless Microphones

	Dažniai / Frequences	Kaina / Price
SHURE ULXD24Q	K51 606-670 MHz	108 ⁰⁰ €
SHURE ULXD24D	K51 606-670 MHz	54 ⁰⁰ €
SHURE QLX-D	K51 606-670 MHz	21 ⁰⁰ €
SHURE UR4D	Q5 740-814 MHz	83 ⁰⁰ €
Shure ULX 24	K51 606-670 MHz	17 ⁰⁰ €
SHURE SLX 24	K51 606-670 MHz	13 ⁰⁰ €
SHURE Antenos 874E		7 ⁰⁰ €
Shure split UA845	500-900 MHz	13 ⁰⁰ €
Shure MIC capsule BETA58		8 ⁰⁰ €
Shure MIC capsule BETA87		8 ⁰⁰ €
Shure MIC capsule SM58		8 ⁰⁰ €
Shure MIC capsule KSM9		13 ⁰⁰ €
HEIL capsule PR35		8 ⁰⁰ €

Kainos nurodytos be PVM / Prices without VAT



Asmeninės monitoringo sistemos / In-Ear Monitoring

Laidinis / Wired	Kaina / Price
Fischer Amps wired IEM beltpack	15 ⁰⁰ €
Behringer Amps wired in ear	10 ⁰⁰ €

Belaidis / Wireless	Kaina / Price
Shure PSM 1000 in ear monitor system	79 ⁰⁰ €

Kainos nurodytos be PVM / Prices without VAT



Shure PSM 1000
in ear monitor system

Pioneer XDJ X2

Didžėjų įranga / DJ Equipment

	Kaina / Price
Pioneer XDJ RX2	49 ⁰⁰ €
Pioneer XDJ X	49 ⁰⁰ €
Pioneer DJM Nexus2	49 ⁰⁰ €
Pioneer CDJ 2000 Nexus 2	49 ⁰⁰ €
Technics SL1210 mk7	49 ⁰⁰ €

Kainos nurodytos be PVM / Prices without VAT



Pioneer DJ
set large Nexus (2x CDJ2000
Nexus2 + DJM900 Nexus2)

Stovai ir kiti reikmenys / Stands & Accessories

	Kaina / Price
K&M MIC stand small	1 ²⁵ €
K&M MIC stand large	1 ⁵⁰ €
K&M MIC stand round base	1 ⁶⁵ €
K&M MIC stand table	1 ²⁵ €
K&M music stand	3 ³⁰ €
K&M music stand light (25W black)	2 ⁵⁰ €
K&M speakerstand 214/6	1 ⁶⁵ €
K&M set MIC stand large (20x large/10x small)	40 ⁰⁰ €
K&M set MIC stand small (10x large/5x small)	18 ⁵⁰ €
Hercules MIC stand round base (one-hand)	3 ³⁰ €
Euromet MIC stand table BT99	1 ⁶⁵ €

Kainos nurodytos be PVM / Prices without VAT



Skaitmeniniai garso pultai / Digital Mixing Consoles

Soundcraft	Kaina / Price
Soundcraft Performer 2	132 ⁰⁰ €
Soundcraft Mini Stagebox 32 RJ 45 & CAT5	54 ⁰⁰ €

Midas	Kaina / Price
Midas M32 & Stage box	157 ⁰⁰ €
Midas DL 32 & CAT5	62 ⁰⁰ €
Midas DL251	70 ²⁵ €

Digico	Kaina / Price
Digico SD10	620 ⁰⁰ €
Digico D-Rack (32in + 16out)	62 ⁰⁰ €
Digico Digi Rack (56in + 32out + 4 pairs AES/EBU out)	207 ⁰⁰ €
Digico Digi Rack D-16C A-net card (for Aviom)	99 ⁰⁰ €
Digico Digi Rack Mini	83 ⁰⁰ €
Digico SD Rack (56in + 32out + 4 pairs AES/EBU out) 192kHz	248 ⁰⁰ €

Allen & Heath	Kaina / Price
Allen&Heath dLive DM64 mixer (64in + 32out, 128x128 channel mixer, 96kHz, FPGA XCVI core)	199 ⁰⁰ €
Allen&Heath DX-168 - portable audio expander for dLive/SQ/Avantis (16in+ 8out, 96kHz)	39 ⁰⁰ €
Allen&Heath dLive S7000 control surface	399 ⁰⁰ €
Allen&Heath dLive S5000 control surface	299 ⁰⁰ €
Allen&Heath M-Dante Option Card (including M-DL-ADAPT module, 64x64 channels, 48kHz)	49 ⁰⁰ €
Allen&Heath GigaACE Option Card (128x128 channels, 96kHz)	49 ⁰⁰ €
Allen&Heath dLive CDM32 portable mixer (32in + 16out, 128x128 channel mixer, 96kHz, FPGA XCVI core)	159 ⁰⁰ €
Allen&Heath SQ5 mixer (16in + 12out analogue, 48 channels, 16 mix buses, FPGA XCVI core)	179 ⁰⁰ €

	Kaina / Price
Waves SG Extreme Server V3	99 ⁰⁰ €

Kainos nurodytos be PVM / Prices without VAT



Soundcraft
si performer 2



Midas M32



Allen & Heath
S7000

Back line

		Kaina / Price
Mušamųjų komplektas	Sonor	250 ⁰⁰ €
Mušamųjų komplektas	Pearl Master	250 ⁰⁰ €
Mušamųjų komplektas	Tama	125 ⁰⁰ €
Gitarinis kubas	Mark Bas 4X 10"	40 ⁰⁰ €
Gitarinis kubas	Ampeg SVT-410HLF	25 ⁰⁰ €
Gitarinis kubas	Fender 65 Twin Reverb	52 ⁰⁰ €
Gitarinis kubas	Carvin Nomand	45 ⁰⁰ €
Klavišiniai	Yamaha Motif 6	35 ⁰⁰ €
Klavišiniai	Nord Stage3 (88)	120 ⁰⁰ €
Viengubas klavišų stovas	K&M	10 ⁰⁰ €
Dvigubas klavišų stovas	K&M	18 ⁰⁰ €
Natų stovai (pupitrai/pultai)	K&M	5 ⁰⁰ €
Būgnininko kėdutė	K&M	5 ⁰⁰ €
Klavišininko kėdutė	K&M	5 ⁰⁰ €
Orkestro kėdės	K&M	5 ⁰⁰ €

Kainos nurodytos be PVM / Prices without VAT





Evanescence
koncertas
Trakuose,
2017

Midas M32 kompletas / Midas M32 set

150⁰⁰ €

Mixing console Midas M32

1x

Midas Stage Box DL32

1x

Klark Teknik NCAT50E-50m

1x

Kainos nurodytos be PVM / Prices without VAT

Max 32 input channels



Midas M 32 Bundle

Klark Teknik
NCAT50E-50m



Midas
Stage Box DL32



Allen&Heath dLive S7000 kompletas / Allen&Heath dLive S7000 set

	490⁰⁰ €
Mixing console Allen & Heat dLive S700	1x
Stage box DM64	1x
Dante card	1x
gigaACE card	1x
I/O Expanders DX168	4x
Waves3 (extra order)	1x
50m drum of EtherFlex Cat5	2x
20m drum of CAT6	4x

Kainos nurodytos be PVM / Prices without VAT

Max 128 input channels



Mixing console
Allen & Heat dLive S700



Stage box DM64



Dante card

gigaACE card



I/O Expanders
DX168



4x



Waves3
(extra order)



Donny Montell
koncertinis turas
2018



Apšvietimas / Lighting

ELATION

Judantys prožektoriai /
Moving Lights

Tradiciniai prožektoriai /
Conventional Lights

Bendra įranga /
General Equipment

Priedai /
Accessories

Dūmų ir rūko mašinos, ventiliatoriai, CO₂ ir konfeti patrankos /
Smoke and Haze Machines, Fans and CO₂ Confetti Cannons



Nuo 2015 m.

Kasmet nuo 2015 metų per Lietuvos nepriklausomybės atkūrimo dieną mes sukuriame ir įgyvendiname po išskirtinį projektą, kuris sulaukia itin daug žiniasklaidos ir visuomenės dėmesio.

Apšviečiame visą Baltijos jūros pakrantę nuo Palangos tilto. Jūros paviršiuje atsispindinčios Lietuvos trispalvės ilgis nuo tilto pabaigos iki smėlėtos pakrantės siekė 350 metrų.

Lietuvos nepriklausomybės atkūrimo dieną 2016 m. Klaipėdos senamiestyje sumontavome dar vieną kvapą gniaužiančių šviesų instaliaciją.



From 2015 m.

Every year on the Day of Restoration of Lithuania's Independence, we create and implement an exceptional project, which receives a lot of attention from the media and the society.

In 2015, we illuminated the entire coast of the Baltic Sea from the point of Palanga bridge. The colours of the national flag of Lithuania reflected above the sea in the form of a tricolour strip, which length was up to 350 meters, extending from the end of the bridge to the sandy coast.

On the Day of Restoration of Lithuania's Independence in 2016, we assembled another fascinating installation of lights in the old town of Klaipėda.



Platinum Beam 5R



Renginių idėja /
Event Idea



ELATION SIXBAR IPI000



ELAR Ex Tribar

LIETUVOS
NEPRIKLAUSOMYBĖS
ATKŪRIMO
DIENA

THE DAY OF
RESTORATION
OF LITHUANIA'S
INDEPENDENCE



Švyturio arena
2019 02 16

Palanga
2018 02 16



Pirmasis tikslus
**TAŠKINIS, LAZERINIS
IR IŠSKLAIDYTOS ŠVIESOS
PROŽEKTORIUS**
su **ATSKIROMIS OPTINĖMIS
SISTEMOMIS**,
užtikrinančiomis sklandų veikimą!

The first true
**SPOT, BEAM AND
WASH FIXTURE**
with **INDEPENDENT OPTICAL
SYSTEMS**
without compromising performance!



WINNER OF
PLASA AWARDS FOR INNOVATION



	Kaina / Price
Elation Cuepix WW2 (LED Blinder 2x100W, 3p XLR)	8 ⁰⁰ €
Elation Cuepix WW4 (LED Blinder 4x100W, 3p XLR)	12 ⁵⁰ €
Elation TVL3000-II DW (24x3W Cool white & warm white LED)	20 ⁵⁰ €
Elation Cuepix Panel (RGB LED COB Engine, 25x30W, 5p & 3p XLR)	25 ⁰⁰ €
Elation Elar EX Tribar (18x3W RGB LEDs, IP65, 3p XLR)	16 ⁵⁰ €
Elation EXTOW bar HP (12x5W RGBW LEDs, IP65, 3p XLR)	20 ⁵⁰ €
Elation Platinum beam 5R (189 -Watt MSD PLATINUM 5R, 13 colors, 2 gobo wheels, 5p & 3p XLR)	33 ⁰⁰ €
Elation Platinum spot 15R (300 -Watt MSD PLATINUM 15R, 8 colors, 1 gobo wheel, 5p & 3p XLR)	50 ⁰⁰ €
Elation Design Wash LED 60 (RGBW Led Engine, 5p & 3p XLR)	25 ⁰⁰ €
Elation Razor Q12 (RGBW COB Led Engine, 5p XLR)	33 ⁰⁰ €
Elation ACL360Bar (RGBW COB Led Engine, 5p XLR)	29 ⁰⁰ €
Elation Pro FS 15R (MSD Platinum 15R Lamp, 5° - 10° Zoom)	45 ⁵⁰ €
Elation Show Designer II CF (1024 ch. 8 faders, 4 encoders)	29 ⁰⁰ €
Elation DmxBranch 4 (4 ports, 5p & 3p XLR)	8 ²⁵ €
Elation OptoBranch 4 (4 ports, 5p & 3p XLR)	8 ²⁵ €
Elation eNode 8 Pro (Art-Net, sACN, 4096ch., Ethercon, 5p XLR)	12 ⁵⁰ €
ELATION SIXBAR IP1000 (IP65 rated SIXBAR 1000IP™ features (12) 12W 6-IN-1 RGBAW+UV)	29 ⁰⁰ €
Elation Cuepix Strip Tri (RGB LED COB Engine, 5x30W, 5p & 3p XLR)	16 ⁵⁰ €

Kainos nurodytos be PVM / Prices without VAT

ELATION
SIXBAR IP1000



Elation
Platinum spot 15R

EUROVISION
SONG CONTEST
KYIV 2017

OFFICIAL TECHNICAL EVENT SUPPLIER

ELATION

PROFESSIONAL



Artiste Dali

Pardavimas / Sale
4950⁰⁰ €

Nuoma / Rental
100⁰⁰ €



Proteus Hybrid

Pardavimas / Sale
5190⁰⁰ €

Nuoma / Rental
103⁰⁰ €



Platinum FLX

Pardavimas / Sale
4131⁰⁰ €

Nuoma / Rental
82⁰⁰ €



Artiste Monet
Nuoma / Rental
100⁰⁰ €



Artiste DaVinci
Pardavimas / Sale
3222⁰⁰ €
Nuoma / Rental
62⁰⁰ €



Platinum
SEVEN

Pardavimas / Sale
2470⁰⁰ €

Nuoma / Rental
49⁰⁰ €



Fuze Wash Z350

Pardavimas / Sale
1140⁰⁰ €

Nuoma / Rental
32⁰⁰ €

* Pardavimo ir nuomos kaina be PVM / Sale and rental price Excluding VAT

** Suteikiama 2 metų garantija / 2 Years Warranty

Ingos
Valinskienės
koncertas
2019



Judantys prožektoriai / Moving light

	Kaina / Price
Elation Platinum beam 5R (189-Watt MSD PLATINUM 5R, 13 colors, 2 gobo wheels, 5p & 3p XLR)	33 ⁰⁰ €
Elation Platinum spot 15R (300-Watt MSD PLATINUM 15R, 8 colors, 1 gobo wheel, 5p & 3p XLR)	50 ⁰⁰ €
Elation Design Wash LED 60 (RGBW Led Engine, 5p & 3p XLR)	25 ⁰⁰ €
Elation Rayzor Q12 (RGBW COB Led Engine, 5p XLR)	33 ⁰⁰ €
ClayPaky Alpha 1500 (1500W, CMY)	60 ⁰⁰ €
Elation ACL360Bar (RGBW COB Led Engine, 5p XLR)	29 ⁰⁰ €
Martin Mac301 (RGB Led Engine, 5p & 3p XLR)	33 ⁰⁰ €
Elation Platinum SEVEN	49 ⁰⁰ €
Robe Pointe XM Lite Hotbeam 280	69 ⁰⁰ €

Kainos nurodytos be PVM / Prices without VAT

Elation
Platinum beam 5R



Elation
Platinum
Seven



Elation
Design Wash
LED 60



XM Lite
Hotbeam 280



Elation
Platinum spot 15R



ClayPaky
Alpha 1500



Tradiciniai prožektoriai / Conventional Light

	Kaina / Price
PAR tipo prožektoriai / Pars	
Ultralite PAR 64 short (1000W)	6 ⁰⁰ €
Ultralite PAR 64 long (1000W)	6 ⁰⁰ €
Ultralite PAR 64 6-Bar (6x1000W, Harting)	8 ⁰⁰ €
Ultralite PAR 56 short ACL 4-Bar (4x100w VN5P)	4 ⁰⁰ €
Ultralite PAR 56 long (500W)	4 ⁰⁰ €
Baltos šviesos prožektoriai / Blinders	
Elation Cuepix WW2 (LED Blinder 2x100W, 3p XLR)	8 ⁰⁰ €
Elation Cuepix WW4 (LED Blinder 4x100W, 3p XLR)	12 ⁵⁰ €
Showtec Blinder 4 (4x650W, 3p XLR)	12 ⁵⁰ €
Showtec Blinder 2 (2x650W, 3p XLR)	8 ⁰⁰ €
Profiliniai prožektoriai / Profilespots	
ADB HPZ215Z (2000W, 15° - 40°)	29 ⁰⁰ €
ETC Source Four Zoom (500W, 750W, 25° - 50°)	16 ⁵⁰ €
Robert Juliat 614S	16 ⁵⁰ €
Spotlight DTS ST1000a PC	12 ⁵⁰ €

Kainos nurodytos be PVM / Prices without VAT

ETC
Source Four
Zoom



Spotlight
DTS ST1000a PC



Elation
Cuepix WW4

Showtec
Blinder 4



Užliejimo ir specialios paskirties prožektoriai / Flood lights and special lights

	Kaina / Price
Užliejimo prožektoriai / Flood lights	
Elation TVL3000-II DW (24x3W Cool white & Warm white LED)	20 ⁵⁰ €
Sylvania Flood2k	6 ⁵⁰ €
Spalvų keitikliai / Color changers	
Elation Cuepix Panel (RGB LED COB Engine, 25x30W, 5p & 3p XLR)	25 ⁰⁰ €
Eurolite FLD-252 (252x10mm LEDs, 3p XLR)	10 ⁰⁰ €
Elation Paladin 6° To 32° Motorized Zoom Range (24) 40W RGBW 4-in1 LEDs IP 65	49 ⁰⁰ €
Studio due City color 1800	199 ⁰⁰ €
Linijiniai prožektoriai / Bars	
Elation Elar EX Tribar (18x3W RGB LEDs, IP65, 3p XLR)	16 ⁵⁰ €
Elation EXTQW Bar HP (12x5W RGBW LEDs, IP65, 3p XLR)	20 ⁵⁰ €
Elation Cuepix Strip Tri (RGB LED COB Engine, 5x30W, 5p & 3p XLR)	16 ⁵⁰ €
Elation SIXBAR IP1000 (IP65 rated SIXBAR 1000IP™ features (12) 12W 6-IN-1 RGBAW+UV)	29 ⁰⁰ €
SGM Ribalta ip65	70 ⁰⁰ €
PAR tipo LED šviesos diodų prožektoriai / LED Pars	
Eurolite LED Par Black (10mm LEDs, 3p XLR)	4 ⁰⁰ €
TransSpot 10mm (10mm LEDs, 3p XLR)	5 ⁰⁰ €
TransSpot 24x5W (24xRGBW LEDs, 3p XLR)	7 ⁵⁰ €
Flash LED PAR64 Flat (10mm LEDs, 3p XLR)	4 ⁰⁰ €
Sekiojamo spindulio prožektoriai / Follow Spots	
Elation Pro FS 15R (MSD Platinum 15R Lamp, 5° - 10° Zoom)	45 ⁵⁰ €
Clay Paky Shadow QS-ST (Osram HMI 1200, 5,5° - 12°, 5p DMX)	50 ⁰⁰ €
Dekoratyvinis apšvietimas / Decoration Light	
Eurolite Mirror ball (50cm)	16 ⁵⁰ €
Eurolite MD-1515 motor	8 ⁰⁰ €
Eurolite LED CRT-120 (2.4m x 3.2m, 3p DMX)	16 ⁵⁰ €
Outdoor Festoon lights (50m, Schuco)	66 ⁰⁰ €
Stroboskopai / Strobes	
Martin Atomic 3000 (3000W, 5p & 3p XLR)	20 ⁰⁰ €

Kainos nurodytos be PVM / Prices without VAT



Elation
Cuepix
Panel

Apšvietimo pultai / Lighting consoles

	Kaina / Price
Elation Show Designer II CF (1024 ch., 8 faders, 4 encoders)	29 ⁰⁰ €
ChamSys MQ80 (24576 ch., 13 faders, 8 encoders)	165 ⁰⁰ €
MA Lighting grand MA2 light	318 ⁰⁰ €
ChamSys MQ500	200 ⁰⁰ €
ChamSys Extra wing	35 ⁰⁰ €

Kainos nurodytos be PVM / Prices without VAT



ChamSys MQ500



MA Lighting grand MA2 light

Priedai / Accessories

	Kaina / Price
Apsauga nuo lietaus / Rain covers	
Elation WP-02 (104mm diameter, IP44)	42 ⁰⁰ €
Stovai / Stands	
Guil ELC-500 (100 kg 3.2 m)	25 ⁰⁰ €
Guil ELC-503 (125 kg 3.2 m)	29 ⁰⁰ €
Guil ELC-506 (250 kg 5.2 m)	50 ⁰⁰ €
JB-Systems LS-380 (80 kg 3.8 m)	16 ⁵⁰ €
GUIL FC-03 (60 kg 500 cm)	20 ⁰⁰ €
Kabinamos įrangos priedai / Rigging accesories	
GLP U-Torm Modular Truss (60 x 5 x 76 cm, 50 kg, 10 Units max)	13 ⁰⁰ €
Doughty T-Bar 150 (150x80x5 cm, 100 kg)	8 ²⁵ €
Doughty T-Bar 200 (200x80x5 cm, 100 kg)	10 ⁰⁰ €

Kainos nurodytos be PVM / Prices without VAT



Dūmų ir rūko mašinos, ventilatoriai ir CO₂ konfeti patrankos / Smoke and Haze Machines, Fans and CO₂ Confetti Cannons

	Kaina / Price
Smoke machines	
Antari Z-1500 MK2 (1500W, 570 m ³ /min)	25 ⁰⁰ €
Antari Z-1000 MK2 (1000W, 340 m ³ /min)	15 ⁰⁰ €
Beamz 3500	19 ⁰⁰ €
Magnum 1800	39 ⁰⁰ €
Le Maitre G300	39 ⁰⁰ €
Antari M7	47 ⁰⁰ €
Hazers	
MDG ATMe 199 €	199 ⁰⁰ €
Antari Z-350 Hazer (700W, 85 m ³ /min)	39 ⁰⁰ €
Fan	
MPM MWP-01 Fan	5 ⁰⁰ €
MWP-01 Fan su DMX on.off fan	15 ⁰⁰ €
Eurolite FM-1200	10 ⁰⁰ €
ADJ Entour Cyclone DMX fan	39 ⁰⁰ €
Flamethrowers	
FOS Cold sparks	49 ⁰⁰ €
Showtec 1 flame fire thrower (3p XLR)	19 ⁰⁰ €
Showtec 3 flames fire thrower (3p XLR)	39 ⁰⁰ €
Confetti / Snow	
Confetti	9 ⁹⁹ €
Confetti maker TCMFX e-shot	19 ⁰⁰ €
TCMFX Confetti booster3	99 ⁰⁰ €
Magic FX swirl fan XL	49 ⁰⁰ €
TCMFX CO2 LED	69 ⁰⁰ €
TCMFX CO2 GUN	
Mirrorball	
Mirror ball 50 cm	50 ⁰⁰ €
Mirror ball 100cm	199 ⁰⁰ €
Mirror ball motor	10 ⁰⁰ €
Mirror ball motor DMX	5 ⁰⁰ €

Kainos nurodytos be PVM / Prices without VAT

Vīlītes
bēgimas
2019



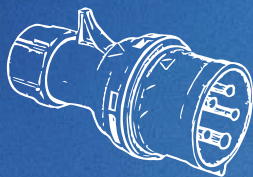

Elektros tiekimas / Power supply

Kabėliai /
Cables

Kabėlių apsaugos /
Cable Ramps

Galios paskirstymas /
Power Distribution

Generatoriai /
Generators





ProDJ pasirūpina saugiu reikiamos galios elektros tiekimu ir paskirstymu bet kuriame renginyje. Tai viena iš sričių, į kurią visiems organizatoriams siūlome atkreipti ypatingą dėmesį, netaupyti ir nerizikuoti. Netinkamai įrengus laikinę įvadą ar netinkamai paskirsčius elektros apkrovas gali dingti ne tik garsas, šviesa, bet ir neįvykti renginys. Šioje sferoje esame ypač principingi ir laikomės ypatingos saugos. Mes galime išnuomoti dyzelinius generatorius nuo 16 iki 240 (kW). Distributorius nuo 32, 63, 125 ir 400 (A) bei visus reikiamus kabelius.



ProDJ takes care of a safe power supply and distribution at any kind of event. This is one of the areas where we offer event organizers to pay full attention, not to save and not to risk. When failing to install a temporary input or incorrect allocation of electrical loads may not only result in the loss of sound and light but also the event. Especially in this area we are particularly principle and we always keep special safety. We can rent diesel generators from 16 up to 240kW. Distributors from 32, 63, 125 up to 400 A. And all required cables.



Renginių idėja /
Event Idea



CEE kištukas /
CEE plug



Power distro 400 A

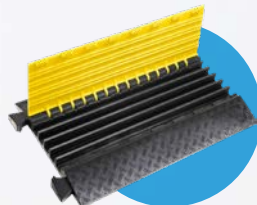

Adam Hall defender



Sveika
Neringa
2019

Kabeliai / Cables

Schuko	Kaina / Price
Cable Schuko 3×2.5 m ² - 2.5 m	1 ⁰⁰ €
Cable Schuko 3×2.5 m ² - 5 m	1 ²⁵ €
Cable Schuko 3×2.5 m ² - 10 m	1 ⁴⁵ €
Cable Schuko 3×2.5 m ² - 15 m	1 ⁶⁵ €
Cable Schuko 3×2.5m ² - 25 m	2 ⁰⁰ €
Cable Schuko 3×2.5 m ² - 50 m	3 ⁷⁰ €
Conversion shuko CEE 16 > 3×220v - 1 m	1 ⁶⁵ €
Conversion shuko CEE 32 > 3×220v - 1 m	2 ⁰⁰ €
Conversion shuko CEE 16 A 3p > 4×220v - 5 m	2 ⁰⁰ €
Conversion Schuko CEE 32A > 3×32A	3 ³⁰ €
Cable set shuko (15×2.5 m + 15×5 m + 15×10 m + 10×15 m + 5×25 m)	50 ⁰⁰ €

Powercon	Kaina / Price
Cable Powercon 1,5 m ² - 1 m	0 ⁴¹ €
Cable Powercon 1,5 m ² - 2 m	0 ⁵⁰ €
Cable Powercon 1,5 m ² - 3 m	0 ⁶⁰ €
Cable Powercon 2,5 m ² - 1 m	0 ⁵⁰ €
Cable Powercon 2,5 m ² - 2 m	0 ⁶⁰ €
Cable Powercon 2,5 m ² - 3 m	0 ⁶⁵ €
16A 3 pin > Powercon 2,5 m ² - 3 m	0 ⁸⁵ €
16A 3 pin > Powercon 2,5 m ² - 4.5 m	1 ⁰⁰ €
16A 3 pin > Powercon 2,5 m ² - 6 m	1 ¹⁵ €

CEE 16A	Kaina / Price
Cable CEE 16A > 16A, 5×4 mm ² - 10 m	2 ⁰⁰ €
Cable CEE 16A > 16A, 5×4 mm ² - 15 m	2 ²⁰ €
Cable CEE 16A > 16A, 5×4 mm ² - 20 m	3 ⁷⁰ €
Cable CEE 16A > 16A, 5×4 mm ² - 25 m	4 ⁵⁰ €
Cable CEE 16A > 16A, 5×4 mm ² - 30 m	5 ⁵⁰ €
CEE 16A > 6×Schuko/16A/Split Box	4 ⁵⁰ €
CEE 16A > 6×Schuko/Split Box	4 ⁵⁰ €
Conversion CEE 16A > CEE 32A, 5×4 mm - 2 m	2 ¹⁰ €

Kainos nurodytos be PVM / Prices without VAT

Kabeliai / Cables

CEE 32A	Kaina / Price
Cable CEE 32A > 32A, 5×4mm ² - 10 m	2 ¹⁰ €
Cable CEE 32A > 32A, 5×4mm ² - 15 m	2 ⁹⁰ €
Cable CEE 32A > 32A, 5×4mm ² - 20 m	3 ⁷⁰ €
Cable CEE 32A > 32A, 5×4mm ² - 25 m	4 ⁵⁵ €
Cable CEE 32A > 32A, 5×6mm ² - 10 m	2 ⁹⁰ €
Cable CEE 32A > 32A, 5×6mm ² - 15 m	4 ²⁰ €
Cable CEE 32A > 32A, 5×6mm ² - 20 m	5 ⁴⁰ €
Cable CEE 32A > 32A, 5×6mm ² - 25 m	6 ⁶⁰ €
Cable CEE 32A > 32A, 5×6mm ² - 30 m	8 ⁰⁰ €
CEE 32A > 6×Schuko/32A/Split Box	4 ²⁰ €
CEE 32A > 3×CEE 16A 3p/Split Box	4 ²⁰ €
CEE 32A > 6×CEE 16A 3p/Split Box	4 ²⁰ €
Conversion CEE 32A > CEE 63A, 5×10 mm - 2 m	4 ²⁰ €
Conversion CEE 32A > CEE 16A, 5 ×6 mm - 2 m	4 ²⁰ €

CEE 63A	Kaina / Price
Cable CEE 63A > 63A, 5×16mm ² - 5 m	4 ²⁰ €
Cable CEE 63A > 63A, 5×16mm ² - 10 m	5 ⁰⁰ €
Cable CEE 63A > 63A, 5×16mm ² - 15 m	8 ⁰⁰ €
Cable CEE 63A > 63A, 5×16mm ² - 25 m	12 ⁵⁰ €
Cable CEE 63A > 63A, 5×16mm ² - 50 m	20 ⁵⁰ €
Conversion CEE 63A > CEE 125A, 5×25 mm - 2 m	8 ⁰⁰ €

CEE 125A	Kaina / Price
Cable CEE 125A > 125A, 5×25 mm ² - 5 m	8 ⁰⁰ €
Cable CEE 125A > 125A, 5×25 mm ² - 10 m	12 ⁵⁰ €
Cable CEE 125A > 125A, 5×25 mm ² - 15 m	14 ⁵⁰ €
Cable CEE 125A > 125A, 5×25 mm ² - 20 m	16 ⁵⁰ €
Cable CEE 125A > 125A, 5×25 mm ² - 25 m	18 ⁶⁰ €
Cable CEE 125A > 5×Powerlock 5×150 mm ² - 1 m	10 ³⁰ €

Kainos nurodytos be PVM / Prices without VAT

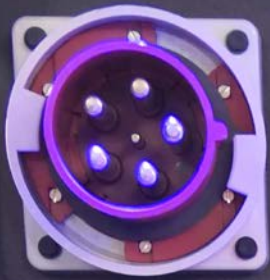

EMERSON T. CE

L1 = Phase L1
L2 = Phase L2
L3 = Phase L3
H1 = Ground
H2 = Ground

L1 L2 L3 H1 H2

19 PIN Outlet #1

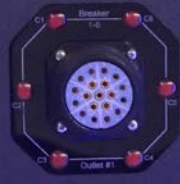

19 PIN Outlet #2

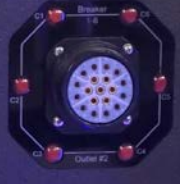

19 PIN Outlet #3

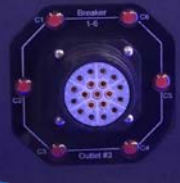

19 PIN Outlet #4

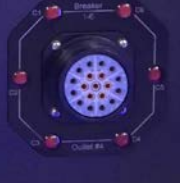

SOCAPEX 10



SOCAPEX 11



SOCAPEX 12



CEE 16A/ 3PIN	Kaina / Price
Cable 16A > 16A, 3×2.5mm ² - 5 m	1 ²⁵ €
Cable 16A > 16A, 3×2.5mm ² - 10 m	2 ¹⁰ €
Cable 16A > 16A, 3×2.5mm ² - 20 m	2 ⁹⁰ €
Cable 16A > 16A, 3×2.5mm ² - 25 m	3 ⁷⁰ €
Cable 16A > 16A, 3×2.5mm ² - 5 m	4 ⁵⁵ €
Cable 16A > 3×Schuko/3×2.5mm ² - 3 m	1 ²⁵ €
Cable 16A > 3×Schuko/3×2.5mm ² - 6 m	2 ¹⁰ €
Cable 16A > 3×Schuko/3×2.5mm ² - 10 m	2 ⁹⁰ €
Schuko Cable > 16A/3×2.5mm ² - 5 m	1 ²⁵ €
Cable 32A > 16A, 3×2.5mm ² - 10 m	2 ⁵⁰ €
CEE 16A > 6×Schuko/16A/Split Box	4 ⁰⁰ €
CEE 16A > 6×Schuko/Split Box	4 ⁰⁰ €

Kabelių apsaugos / Cable Ramp (defender)

	Kaina / Price
Cable Ramp 3 Channels	2 ⁵⁰ €
Cable Ramp 5 Channels	4 ⁰⁰ €

Kainos nurodytos be PVM / Prices without VAT

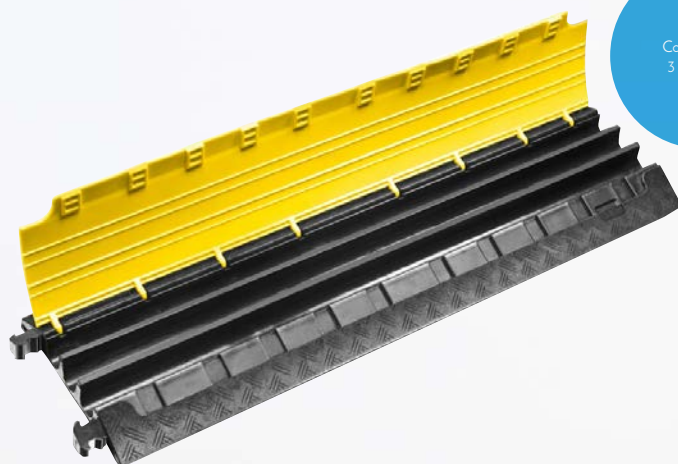

Cable Ramp
3 Channels

Galios paskirstymas / Power Distribution

	Kaina / Price
PSU CEE 32A > 3xCEE 16A 3p	8 ⁰⁰ €
PSU CEE 32A > 3xCEE 16A 3p / 3xSchuko	12 ⁵⁰ €
PSU CEE 32A > CEE 32A / 3xCEE 16A 3p	16 ⁵⁰ €
PSU CEE 32A > CEE 32A / CEE 16A / 4xSchuko	25 ⁰⁰ €
PSU CEE 32A > 4xCEE 16A	25 ⁰⁰ €
PSU CEE 32A > 3xCEE 32A / 6xSchuko	25 ⁰⁰ €
PSU CEE 63A > CEE 63A / CEE 32A / CEE 16A / 8xSchuko	50 ⁰⁰ €
PSU CEE 63A > CEE 63A / 2xCEE 32A / 3xCEE 16A / 6xSchuko	50 ⁰⁰ €
PSU CEE 63A > 2xCEE 63A / 3xCEE 32A / 6xSchuko	50 ⁰⁰ €
PSU CEE 63A > 4xCEE 32A	50 ⁰⁰ €
PSU CEE 125A > 2xCEE 63A / 4xCEE 32A / 2xCEE 16A / 2xCEE 16A 3p / 1xCEE 32A 3p / 6xSchuko	83 ⁰⁰ €

Generatoriai / Generators

	Kaina / Price
SDMO R135C3, Portable Generator, 10kW	35 ⁰⁰ €
Atlas Copco QAX 20KD, Portable Generator, 16kW	65 ⁰⁰ €
J33K, Portable Generator, 24kW	45 ⁰⁰ €
SDMO R44C3, Portable Generator, 32kW	75 ⁰⁰ €
SDMO J66K, Portable Generator, 48kW	99 ⁰⁰ €
SDMO J88K, Portable Generator, 64kW	103 ⁰⁰ €
SDMO J165K, Portable Generator, 130kW	153 ⁰⁰ €
SDMO J220K, Portable Generator, 160kW	170 ⁰⁰ €
SDMO R220C3, Portable Generator, 160kW	170 ⁰⁰ €
SDMO R275C3, Portable Generator, 200kW	200 ⁰⁰ €
SDMO V275K, Portable Generator, 200kW	200 ⁰⁰ €
SDMO R330C3, Portable Generator, 240kW	223 ⁰⁰ €

Kainos nurodytos be PVM / Prices without VAT



Atlas Copco
QAX 20KD,
Portable
Generator,
16kW

Bi-2 koncerts,
Liepoja 2019 09 13



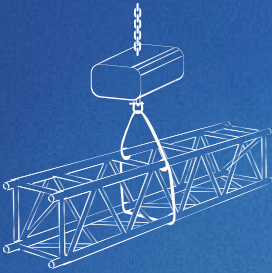

Santvaros ir pakabinimo konstrukcijos / Truss & Rigging

Elektriniai/rankiniai įrangos keltuvai /
Electrical/Manual Hoists

Pakylos /
Staging

Kabinamos įrangos priedai /
Rigging Accessories

Kabliai /
Clamps

Stovai ir kiti reikmenys /
Stands and Accessories

Santvaros /
Trusses

KONCERTAI IR MIESTŲ ŠVENTĖS / CONCERTS AND CITY EVENTS





ProDJ daugybę metų dirba didžiausiose miestų šventėse visose Baltijos šalyse. Mūsų scenos buvo statomos Vilniuje, Kaune, Klaipėdoje, Rygoje, Taline, Palangoje, Nidoje, Panevėžyje...



For many years now, "ProDJ" is working with many city events in all the Baltic countries. Our stages have been built in Vilnius, Kaunas, Klaipeda, Palanga, Nida, Panevezys, Riga, Tallinn and many others...



Baltic Stages" konstrukcijos /
"Baltic Stages" Structures

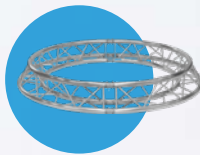
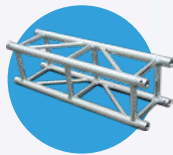
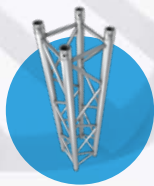

Tvirtinamos sceninės konstrukcijos /
Truss and Staging Structures



Guil Crowd barriers



ChainMaster D8 + 1000kg,
4m/min, chain length 24m

Kabinamos konstrukcijos / Rigging

Elektriniai įrangos keltuvai / Electrical Hoists	Kaina / Price
ChainMaster BGV-D8 electrical hoist 500 kg - 18m Chain (4 m/min)	39 ⁰⁰ €
ChainMaster BGV-D8 electrical hoist 1000 kg - 24m Chain (4 m/min)	40 ⁰⁰ €
ChainMaster BGV-D8 IP66 plus electrical hoist 500 kg - 18m Chain (4 m/min)	49 ⁰⁰ €
ChainMaster BGV-D8 IP66 plus electrical hoist 1000 kg - 25m Chain (4 m/min)	69⁰⁰ €

Rankiniai įrangos keltuvai / Manual Hoists	Price
Powertex manual hoist 1000 kg - 9 m Chain	12 ⁵⁰ €

Keltuvų priedai / Hoist Accessories	Price
Electrical hoist controller 2	25 ⁰⁰ €
Electrical hoist controller 8	50 ⁰⁰ €

Kiti reikmenys / Accesories	Price
White truss circle 6 m	399 ⁰⁰ €
White truss circle 12 m	399 ⁰⁰ €

Kainos nurodytos be PVM / Prices without VAT



CHAINMASTER
BGV-D8

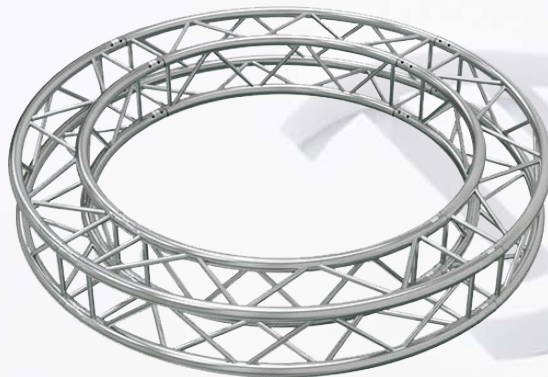

Heiner
Goebbels
"Stiffers Dinge",
2017, Švyrutio
arena

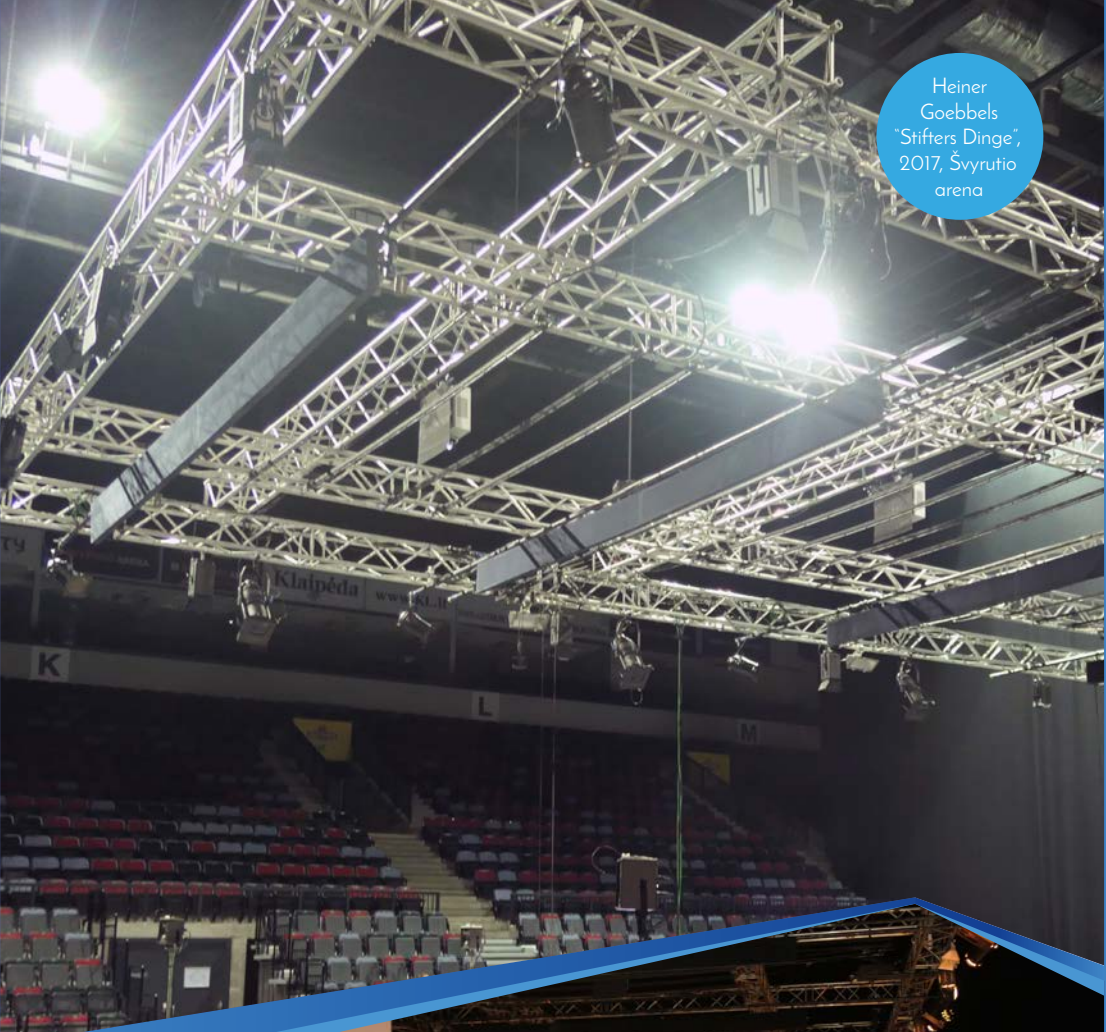



„Šermukšnis
2019“ tarptautinis
gatvės teatru festivalis
2019 07 05-07

Pakylas / Staging	Kaina / Price
Baltic Stages deck 1x0,5 m (Layher compatible)	6 ⁶⁰ €
Baltic Stages deck 1x1 m (Layher compatible)	6 ⁶⁰ €
Baltic Stages deck 2x0,5 m (Layher compatible)	6 ⁶⁰ €
Baltic Stages deck 2x1 m (Layher compatible)	7⁰⁰ €
Baltic Stages leg 0,2 / 0,3 / 0,6 / 0,65 m	0 ⁸⁵ €
Baltic Stages telescopic leg - 0,65 m - 1 m	3 ⁰⁰ €
Baltic Stages telescopic leg - 0,90 m - 1,50 m	4 ⁰⁰ €
Baltic Stages travers 1 m (Layher compatible)	4 ⁰⁰ €
Baltic Stages travers 2m (Layher compatible)	4 ⁰⁰ €
Stairs - H=0,2 / 0,4 / 0,6 / 0,8 m W=0,9 m	16 ⁵⁰ €
Adjustable stairs - H=1-1,5 m W=0,75 m (Layher compatible)	49 ⁰⁰ €

Kabinamos įrangos priedai / Rigging Accessories	Kaina / Price
Adjusting chain 1T - 2 m (topping + hook)	2 ⁵⁰ €
Ratchet black 2.5t 4,5 m/12,5 m	0 ⁸⁵ €
Ratchet black 5t 8 m/12,5 m	2 ⁵⁰ €
Roundsling 1T black - 1 m/1,5 m/2 m/3 m	1 ²⁵ €
Roundsling 2T black - 2 m/3 m	1 ²⁵ €
Shackle 1T/1,5T/2T/3,25T	1 ²⁵ €
Steel 1T - 6,5 m/7,5 m/12 m/13,5m	0 ⁸⁵ €
Layher Ladder - 7m	16 ⁵⁰ €

Vamzdžiai, pastoliai ir spauštuvai / Tubes, Scaffolds & Clamps	Kaina / Price
Alu tube silver Ø 48 mm - 0,4 m + clamp	1 ⁶⁵ €
Alu tube silver Ø 48 mm - 0,6 m + clamp	1 ⁶⁵ €
Alu tube silver Ø 48 mm - 1 m	0 ⁸⁵ €
Alu tube silver Ø 48 mm - 2 m	0 ⁸⁵ €
Doughty clamp alu half (45-52 mm)	1 ⁶⁵ €
Doughty clamp alu half (45-52 mm) + protruss alustage half-connector HC-2	1 ⁶⁵ €
Doughty clamp alu rotating (45-52 mm)	1 ⁶⁵ €

Kainos nurodytos be PVM / Prices without VAT

Santvaros / Trusses

Protruss Duo 290	Kaina / Price
Protruss Alustage AL32 silver - 3m	2 ⁵⁰ €

Protruss Tri 290	Kaina / Price
Protruss Alustage AL33 silver - 1m/1,47 m/2.07m	4 ⁰⁰ €
Protruss Alustage AL33 silver - 2,07 m	4 ⁰⁰ €
Protruss Alustage AL33 silver - boxcorner	4 ⁰⁰ €

Protruss quadro 290	Kaina / Price
Protruss Alustage AL34 silver - 2 m	5 ⁰⁰ €

Protruss quadro 390	Kaina / Price
ALHD4 silver - 0,5m /0,6m/0,716m	6 ⁰⁰ €
Alustage ALHD4 silver - 1m/1,5m/2m/3m/3,47m/4m	5 ⁰⁰ €
Alustage ALHD4 black - 2m/4m	9 ⁰⁰ €
Alustage ALHD4 silver - boxcorner, QUA box	9 ⁹⁹ €
Alustage ALHD4 black - pivot corner	9 ⁹⁹ €
Alustage ALHD4 black - baseplate (0,8 m×0,8 m)	9 ⁹⁹ €

Ant žemės statomos konstrukcijos / Ground Supports	Kaina / Price
Alustage Stage Roof GR tower 2t white - base + top + sleeve + ALHD4 - 0,6 m	83 ⁰⁰ €
Alustage Stage Roof GR tower 2t white - base + top + sleeve + ALHD4 - 0,6m + 4× short outriggers	91 ⁰⁰ €
Alustage Stage Roof GR tower 2t white - 4× long outriggers + stabilisers	66 ⁰⁰ €
Alustage Stage Roof GR tower 2t white - 4× short outriggers	62 ⁰⁰ €
IBC container black - 1000l	19 ⁰⁰ €
IBC container white - 1000l	29 ⁰⁰ €
Concrete block - 1t	19 ⁰⁰ €

Kainos nurodytos be PVM / Prices without VAT



Layher stage base

Layher	Kaina / Price
Base plate - 0,2 m / 0,4 m / 0,6 m / 0,8 m	1 ⁶⁵ €
Base collar	1 ²⁵ €
Standart, steel, with pressed-in spigot - 1 m / 1,5 m / 2 m / 3 m / 4 m	1 ⁶⁵ €
Standart, steel, without spigot - 0,5 / 1 m / 1,5 m / 2 m	1 ⁶⁵ €
Spigot	1 ⁶⁵ €
O-ledger, steel - 1 m / 2m / 2,07 m	1 ⁶⁵ €
O-ledger horizontal diagonal, steel - 2 m×2 m	1 ⁶⁵ €
Diagonal brace, steel - 2 m×0,5 m / 2 m×1 m / 2 m×1,5 m / 2,07 m×2 m	1 ⁶⁵ €
O - console bracket - 0.73 m	1 ²⁵ €
Wedge - head coupler, rigid	1 ²⁵ €
Wedge-head coupler, swivelling	1 ²⁵ €
Clampable rosette, steel	1 ²⁵ €
Layher container - 95 m× 135 m×65 m	8 ⁰⁰ €
Layher stage base 1x1m	149 ⁰⁰ €
Layher stage base 2x1m/ 1x2m	199 ⁰⁰ €
Layher stage base 2x2m	249 ⁰⁰ €

Minios atitvarai / Crowd barriers	Kaina / Price
Guil aluminium crowd barrier	19 ⁰⁰ €
Guil aluminium crowd barriers with door_____29€	29 ⁰⁰ €
Guil aluminium crowd barrier for cables_____19€	19 ⁰⁰ €

Kainos nurodytos be PVM / Prices without VAT



Scenos / Stages

Scenos (plotis, ilgis, aukštis) / Stages (W L H)	Kaina / Price*
12,5x10,5x9,5 with Pa wings (8 Towers)	3 000 ⁰⁰ €
12,5x10,5x9,5 (6 Towers)	2 500 ⁰⁰ €
12,5x10,5x 9,5 (4 Towers)	2 000 ⁰⁰ €
10,5x8,5x9,5	1 500 ⁰⁰ €
10,5x6x9,5	1 300 ⁰⁰ €
10,5x6x6,5	1 250 ⁰⁰ €
8,5x6x6,5	900 ⁰⁰ €
6x4x6	600 ⁰⁰ €

Operatorinės / FOH	Kaina / Price*
3x3 one floor	100 ⁰⁰ €
4x4 one floor	250 ⁰⁰ €
4x2 two floors	250 ⁰⁰ €

Vartai šviesos diodų ekranui / LED gate	Kaina / Price*
W=4 m-8 m/10 m; H=5 m-9 m	520 ⁰⁰ €

Bokšteliai / Towers	Kaina / Price*
2x2 m, H=2-10 m	320 ⁰⁰ €
2x4 m, H=2-10 m	590 ⁰⁰ €
2x6 m, H=2-10 m	890 ⁰⁰ €
4x6 m, H=2-10 m	1 790 ⁰⁰ €

Kainos nurodytos be PVM / Prices without VAT

*Kaina be transporto išlaidų. / The price is provided without transportation costs.



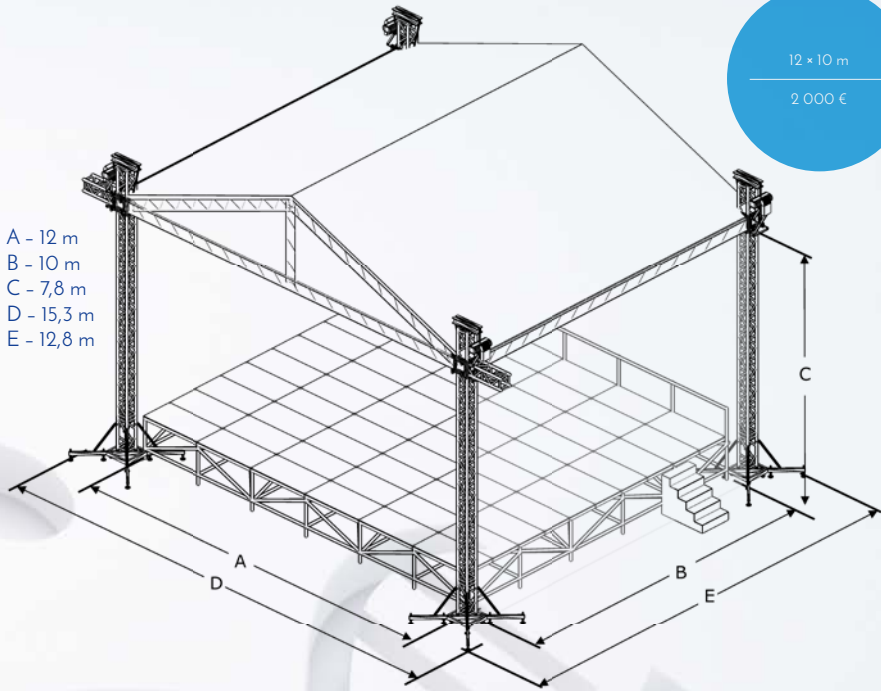

- A - 12 m
- B - 10 m
- C - 7,8 m
- D - 15,3 m
- E - 12,8 m

Main Stage
12 x 10 m 8 towers
2 monitor house

3 000 €

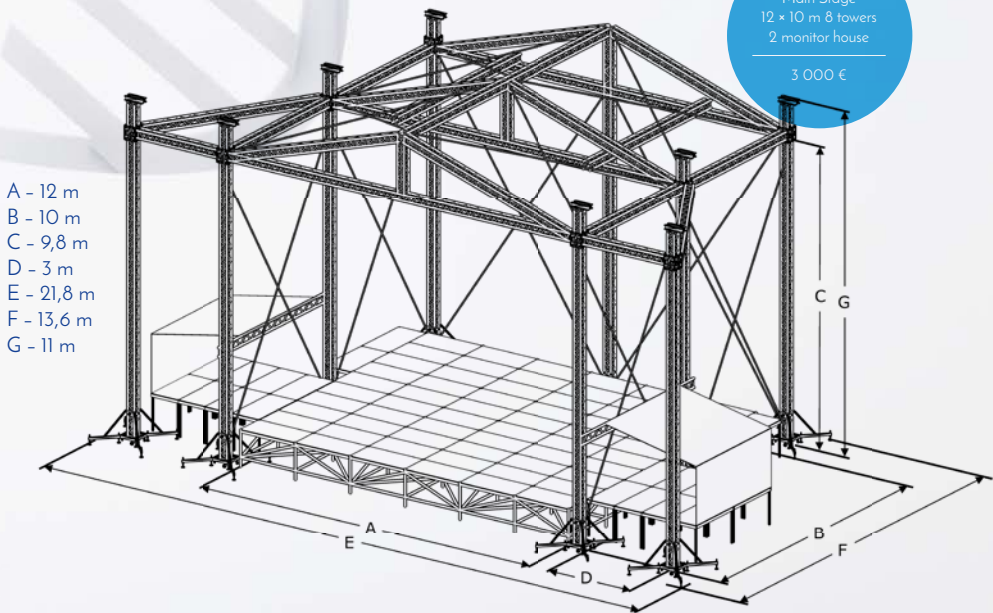

- A - 12 m
- B - 10 m
- C - 9,8 m
- D - 3 m
- E - 21,8 m
- F - 13,6 m
- G - 11 m

- A - 6 m
- B - 5,4 m
- C - 6 m
- D - 8,1 m
- E - 5,4 m

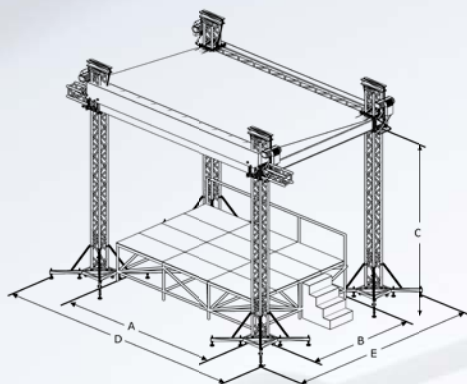

6 × 4 m
600 €

- A - 10 m
- B - 6 m
- C - 7,8 m
- D - 13,3 m
- E - 8,6 m

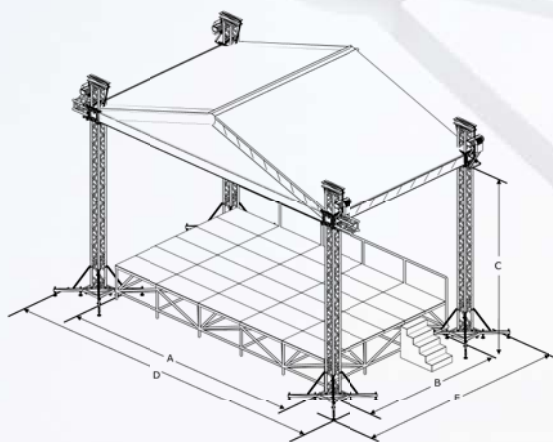

10 × 6 m
1 250 €

- A - 8 m
- B - 6 m
- C - 8,4 m
- D - 11,42 m
- F - 8 m
- G - 10 m

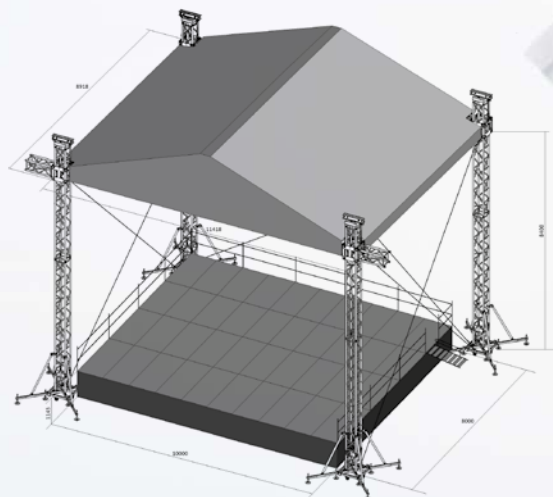

10 × 8 m
1 500 €

Folkšokas 2017
finalinis
koncertas

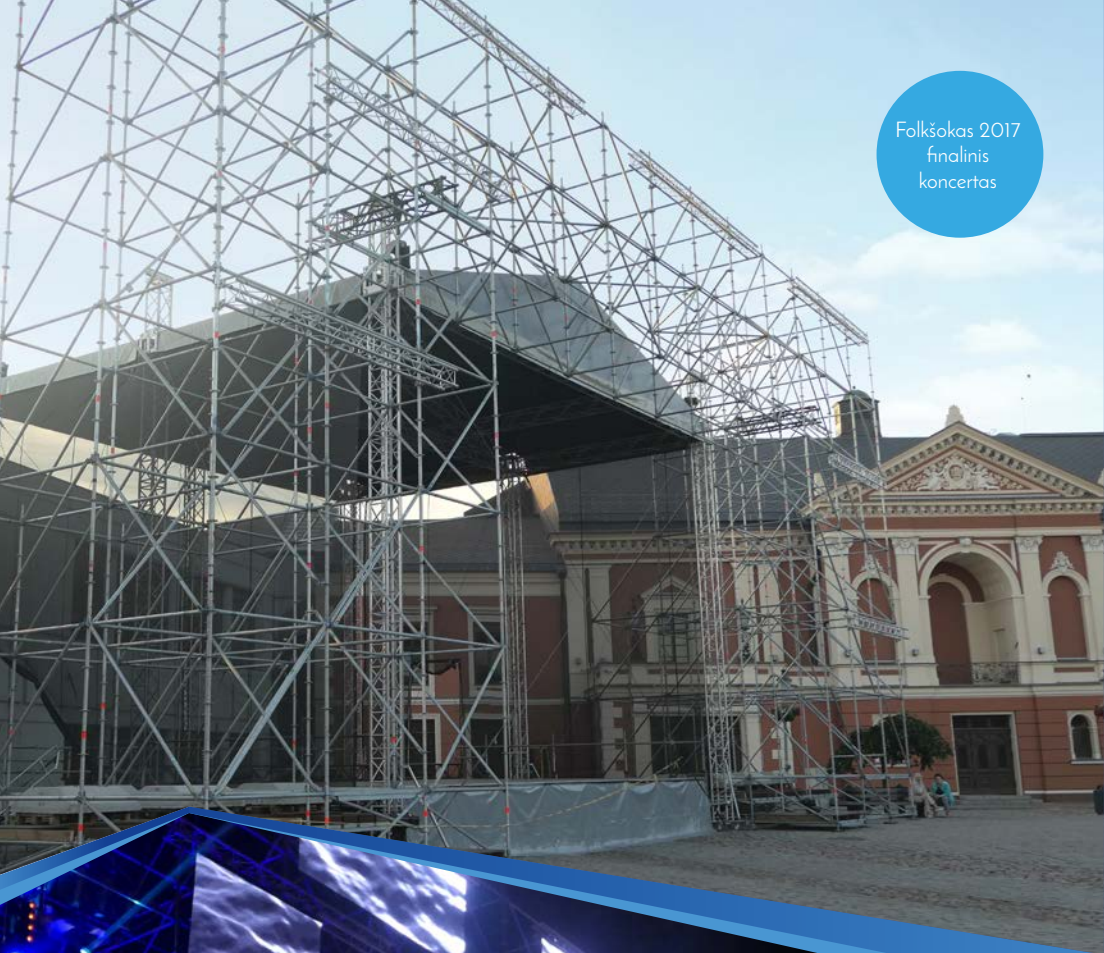



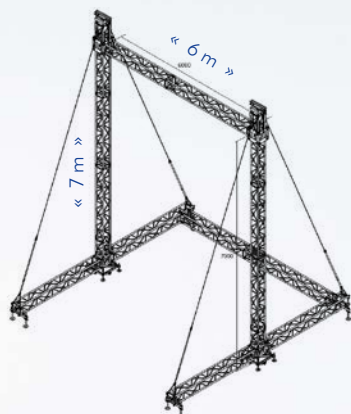

Vartai
šviesos diodų
ekranui 6 x 4 m /
Led gate 6 x 4 m

520 €

Isometric view

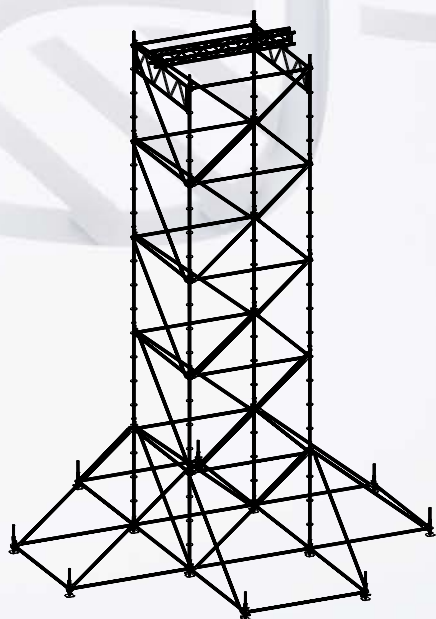

Front view
Scale 1:75

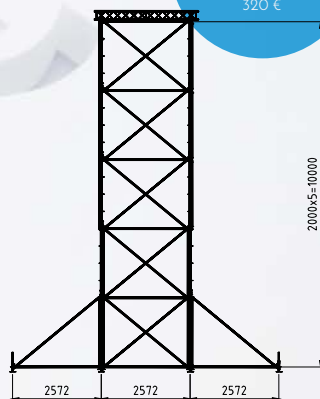

PA sistemos
bokštas 10 m /
PA Tower 10m

320 €

Top view
Scale 1:75

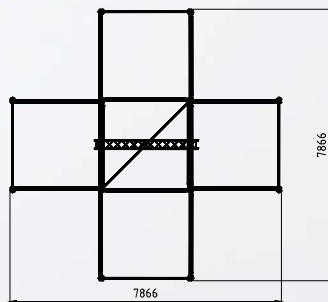

Tribuna 150 vietų /
The tribe 150 seats

1900 €

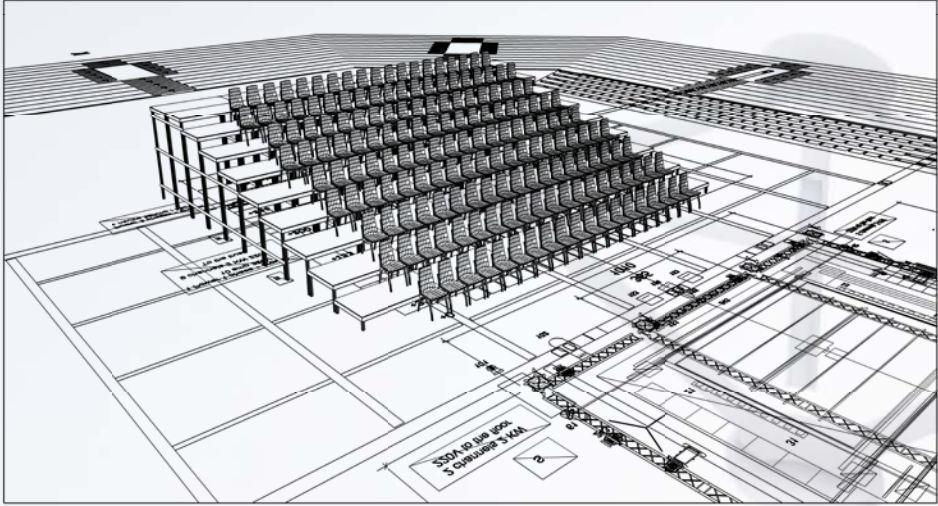

Rinkiniai / SET's

Rinkinys nr. 1 / SET No. 1	vnt. / pcs	Kaina / Price
ChainMaster BGV-D8 electrical hoist 1000 kg - 24 m Chain (4 m/min)	2	99 ⁰⁰ €
Roundsling 1T black - 1,5 m	4	
Electrical hoist controller 2-way	1	
Shackle	4	

Rinkinys nr. 2 / SET No.2	vnt. / pcs	Kaina / Price
ChainMaster BGV-D8 electrical hoist 1000 kg - 24 m Chain (4 m/min)	4	189 ⁰⁰ €
Roundsling 1T black - 1,5 m	4	
Electrical hoist controller 2-way	1	
Shackle	4	

Rinkinys nr. 3 / SET No.3	vnt. / pcs	Kaina / Price
ChainMaster BGV-D8 electrical hoist 1000 kg - 24 m Chain (4 m/min)	4	359 ⁰⁰ €
ChainMaster BGV-D8 electrical hoist 1000 kg - 18 m Chain (4 m/min)	4	
Roundsling 1T black - 1,5 m	16	
Electrical hoist controller 8-way	1	
Shackle	16	

Kainos nurodytos be PVM / Prices without VAT



Koncertas
Dima Bilan
"Bilan Planeta"
2019 04 20



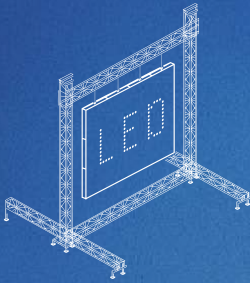

Vaizdo įranga / Video

Šviesos diodų ekranai /
LED Screens

Monitoriai /
Displays

Projektoriai /
Projectors

Procesoriai /
Processors

Keitikliai /
Converters

Kabėliai /
Cables





Renginių idėja /
Event Idea



Šviesos diodų ekranas /
LED video



Elation CUEPIX PANEL



Baltos šviesos sceniniai prožektoriai /
Stage Blinder



Platinum Beam 5R



VIZUALIZACIJOS

Mūsų šviesos diodų ekranai buvo montuojami daugybėje renginių: koncertuose, turuose, vasaros sezono atidarymuose, arenose vykstančiuose renginiuose, privačiuose įmonių vakarėliuose ir t. t.

Šviesos diodų ekranai renginiuose naudojami vaizdo retransliavimui, vizualizacijoms, filmams, sporto varžybų rezultatų rodymui. Turime galimybę sumontuoti šviesos diodų ekranus, kurių dydis nuo 10 m (kv) iki kelių šimtų m (kv).

Mūsų šviesos diodų ekranus galima naudoti įvairiems tikslams – pvz. tiesioginių transliacijų metu, vaizdo įrašų, koncertų vizualizacijų rodymui bei kitų idėjų įgyvendinimui.

VISUALISATIONS

Our LED screens have been built at many events, such as: concerts, tours, openings of the summer season, events at arenas, private corporate parties, etc.

LED screens are used for broadcasting, visualizations, movies, showing sports stats results and etc. We have the opportunity to mount LED screens that are from 10m (kv) to few hundred square meters.

You can use our LED screens for different events or implementation of ideas, for example, to perform live broadcasts, to show video material or visualisations and many other things.

Latvijas
šimtmetis
2018



P6
15 m²
6x4

P6
32 m²
6x3,5

P6
2,5x3,5

P6
2,5x3,5

P6
15 m²
4x3,5

P6
15 m²
4x3,5

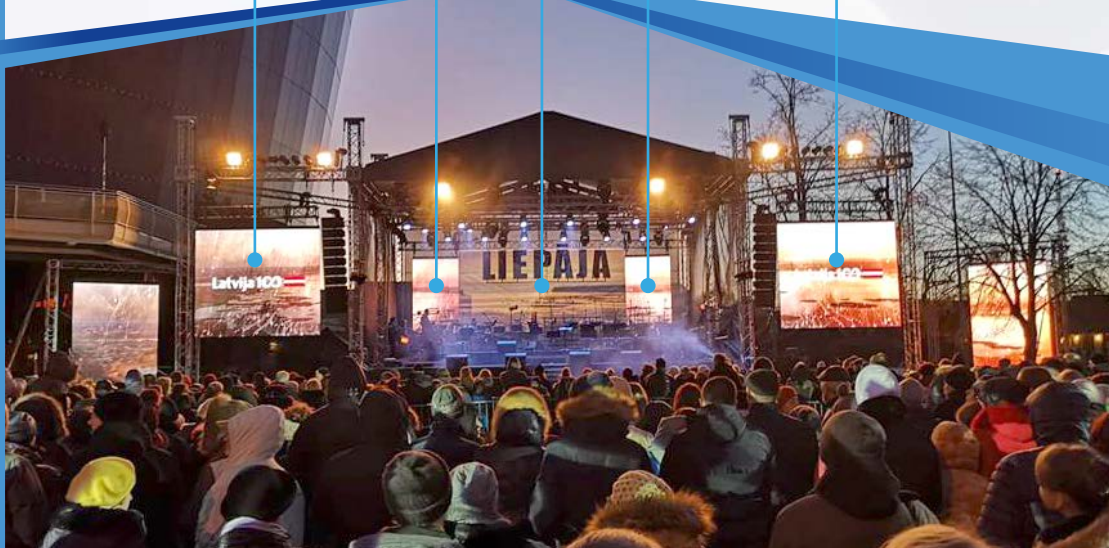

Šviesos diodų ekranai / Led screens		Kaina / Price
Pixel Pitch 12mm, IP65, 2RIGIB, 6000 Nits, 60 Hz	10,6m ² (230x460cm)	600 ⁰⁰ €
Pixel Pitch 12mm, IP65, 2RIGIB, 6000 Nits, 60 Hz	16,5m ² (307x538cm)	900 ⁰⁰ €
Pixel Pitch 12mm, IP65, 2RIGIB, 6000 Nits, 60 Hz	23,6m ² (384x614cm)	1 200 ⁰⁰ €
Pixel Pitch 6mm, IP65, 4000 Nits, 100 Hz	8m ² (200x400cm)	640 ⁰⁰ €
Pixel Pitch 6mm, IP65, 4000 Nits, 100 Hz	15m ² (300x500cm)	1 200 ⁰⁰ €
Pixel Pitch 6mm, IP65, 4000 Nits, 100 Hz	32m ² (400x800cm)	2 400 ⁰⁰ €
Pixel Pitch 4mm IP65 4000 Nits, 100 Hz	8 m ² (200x400)	800 ⁰⁰ €
Pixel Pitch 4mm IP65 4000 Nits, 100 Hz	15 m ² (300x500)	1 500 ⁰⁰ €
Pixel Pitch 4mm IP65 4000 Nits, 100 Hz	32 m ² (400x800)	3 000 ⁰⁰ €
Pixel Pitch 4mm IP65 4000 Nits, 100 Hz	64 m ² 5900.00	5 900 ⁰⁰ €

Monitoriai / Displays	Kaina / 1 m ² / Price / 1 m ²
DELL LCD screen (1920x1080) DVI, VGA	4 ⁰⁰ €
Samsung LCD professional displays 720p (HDMI,VGA)	12 ⁵⁰ €

Projektoriai / Projectors	Kaina / 1 m ² / Price / 1 m ²
BenQ 4000 Liemens (VGA+HDMI)	12 ⁵⁰ €

Procesoriai / Processors	Vieneto kaina / Price / unit
DBS-HVT13E 4ports (HDMI, VGA, DVI, RGB)	29 ⁰⁰ €
ROLAND V4Ex (VGA, DVI, 4HDMI, 4ANALOG)	37 ⁰⁰ €
Blackmagic Design: ATEM Production Studio 4K	207 ⁰⁰ €
DBS-HVT09VP 4ports (HDMI, DVI, VGA)	21 ⁰⁰ €

Keitikliai / Convertors	Kaina / 1 m ² / Price / 1 m ²
BLACKMAGIC HDMI>SDI	16 ⁵⁰ €
BLACKMAGIC ANALOG>SDI	16 ⁵⁰ €
BLACKMAGIC SDI>ANALOG	16 ⁵⁰ €

Kainos nurodytos be PVM / Prices without VAT



P3.91 outdoor rental LED display

2019 metų /
2019 Production

Super lengvas /
Super light

Juodas /
Black

4K



P3.91 outdoor rental LED display

Pixel Pitch (mm)	3.91 mm
LED standard	1921 SMD
Diod type	Black
Refresh rate (Hz)	3840
Brightness (CD/m ²)	4000
Control system Brand	Novastar
Protection Level	IP65
Module size (L × W)	500 × 500 / 500 × 1000
Module weight (KG)	7 kg
View Angle	130°

		Kaina / Price*
6 m ²	300 × 200 cm	444 ⁰⁰ €
11,25 m ²	450 × 250 cm	555 ⁰⁰ €
15 m ²	500 × 300 cm	888 ⁰⁰ €
21 m ²	600 × 350 cm	999 ⁰⁰ €
28 m ² Full HD	700 × 400 cm	1199 ⁰⁰ €
40 m ² Full HD	800 × 500 cm	1599 ⁰⁰ €
54 m ² 4K	900 × 600 cm	2299 ⁰⁰ €

*Yra papildomų sąlygų.

P6 Outdoor rental Led display



P6 Outdoor rental Led display	
Pixel Pitch (mm)	6 mm
LED standard	2R1G1B
Diod type	Black
Refresh rate (Hz)	60
Brightness (CD/m ²)	6000
Control system Brand	Dbstar
Protection Level	IP65
Module size (L × W × H)	768x768 mm
Module weight (KG)	38 kg
View Angle	120°

		Kaina*
10,6 m ²	461 × 230 cm	499 ⁰⁰ €
18,9 m ²	614 × 307 cm	899 ⁰⁰ €
23,6 m ²	614 × 384 cm	999 ⁰⁰ €

Pro DJ.it

TECHNICAL EVENT

CONCEPT ENGINEERING REALISATION



STAGING



RIGGING



LIGHT



SOUND



VIDEO



Logistika / Logistics

Vilikiai /
Trucks

Furgonai /
Vans

Mikroautobusai /
Minibuses

Koeficientai / Coefficient rates

Nuomos terminas / Rate		Koeficientas / Coefficient Rate
1 diena / 1 day	x	1
2 dienos / 2 days	x	1,50
3 dienos / 3 days (weekend)	x	2
1 savaitė / 1 week	x	3
4 savaitės / 4 weeks	x	6
8 savaitės / 8 weeks	x	8

Transp. priemonė / Transport	Kubaturā / Cubage	Svoris / Weight	Paros įkainis / Dayrate	Km įkainis / Km Rate
Minifurgonas / Minivan	1 m ³	0,2 ton	35 ⁰⁰ €	0 ²⁰ €
Furgonas / Van	16 m ³	0,8 ton	30 ⁰⁰ €	0 ³⁰ €
L. didelis furgonas / Van XL	18 m ³	1,1 ton	60 ⁰⁰ €	0 ⁵⁰ €
Vilkikas / Truck	50 m ³	10 ton	120 ⁰⁰ €	0 ⁹⁰ €
Priekaba / Trailer	90 m ³	20 ton	60 ⁰⁰ €	0 ⁵⁰ €

Gabenimas

Gabenimo trukmė dienomis: vietinis (BE) 4 dienos (daugiausiai)
tarptautinis 6 dienos (daugiausiai)

Ilgalaikė nuoma (daugiau nei 8 savaitės)

Dėl ilgalaikės nuomos, individualiai aptartos nuomos ir išperkamosios nuomos paslaugų prašome susisiekti su mumis.

Transport

Transport days: domestic (BE) 4 days (max)
abroad 6 days (max)

Long term rentals (+8 weeks)

Long term rentals, customized rentals, leasing: please contact us.

Komanda ir pagalba / Team and Assistance

Pagalbiniai darbuotojai / Stage-hand	0 - 4 val. / Hrs	0 - 8 val. / Hrs	0 - 16 val. / Hrs
	48 ⁰⁰ €	80 ⁰⁰ €	160 ⁰⁰ €

Specialistas / Technician	0 - 4 val. / Hrs	0 - 8 val. / Hrs	0 - 16 val. / Hrs
Garso / Audio	100 ⁰⁰ €	150 ⁰⁰ €	200 ⁰⁰ €
Apšvietimo / Light	100 ⁰⁰ €	150 ⁰⁰ €	200 ⁰⁰ €
Vaizdo / Video	100 ⁰⁰ €	150 ⁰⁰ €	-
Kabinamos įrangos / Rigger	160 ⁰⁰ €	300 ⁰⁰ €	-

Inžinierius / Engineer	0 - 4 val. / Hrs	0 - 8 val. / Hrs	0 - 16 val. / Hrs
Garso / Audio	200 ⁰⁰ €	300 ⁰⁰ €	400 ⁰⁰ €
Apšvietimo / Light	200 ⁰⁰ €	300 ⁰⁰ €	400 ⁰⁰ €
Vaizdo / Video	200 ⁰⁰ €	300 ⁰⁰ €	-
Kabinamos / Rigger	250 ⁰⁰ €	350 ⁰⁰ €	-

Kainos nurodytos be PVM / Prices without VAT



Evanescence
koncertas,
Trakai, 2017



Rekomendacijos organizuojantiems viešuosius pirkimus



1. Pirkimą dėl scenos, LED ekrano nuomos, įgarsinimo, apšvietimo ar kitos panašios paslaugos skelbti reikia ne vėliau kaip likus 2 mėnesiams iki renginio pradžios.



2. Neperrašinėkite, nekeiskite ir nesistenkite suvienodinti grupių ar atlikėjų keliamų techninių reikalavimų. Geriau visus šiuos reikalavimus, kaip atskirą dokumentą, pridėkite prie pirkimo medžiagos. Prie keliamų reikalavimų rekomenduojame parašyti, kad siūlomos įrangos techninės charakteristikos turi pilnai atitikti grupių ir atlikėjų keliamus techninius reikalavimus (raiderius), kurie yra neatsiejama šio pirkimo dalis, pridėdama priedu Nr.1.



3. Organizuodami viešąjį pirkimą prašykite pateikti:
 - Detalų įgarsinimo įrangos sąrašą, nurodant reikiamą elektros galingumą bei įrangos, kurią būtina kabinti ant scenos, svorį.
 - Detalų apšvietimo įrangos sąrašą, nurodant reikiamą elektros galingumą bei įrangos, kurią būtina kabinti ant scenos, svorį.
 - Siūlomo LED ekrano pagrindines technines charakteristikas (išmatavimai, svoris, atstumas tarp pikselių centrų (P), šviesumas, reikiamas elektros galingumas).



Būtinai prašykite nurodyti reikiamus elektros galingumus, tam kad šią informaciją galėtumėte laiku pateikti elektrikams (renginiams, vykstantiems ne arenose, gan dažnai prireikia papildomų elektros generatorių).



Būtinai prašykite nurodyti visos kabinamos įrangos (LED ekranų, garso aparatūros, apšvietimo) bendrą svorį, tam kad galėtumėte tinkamai parengti reikalavimus scenos pirkimui.



4. Organizuokite scenos pirkimą tada, kai jau yra įvykęs visos kitos įrangos nuomos paslaugų pirkimas ir jau žinote garso operatorių, apšvietėjų, LED ekranų ir dekoratorių keliamus reikalavimus scenai. Scenos pastatymo paslaugos pirkimą skelbkite tada, kai turėsite atsakymus į šiuos klausimus:
 - koks turi būti jos aukštis;
 - kiek svers įranga, kurią planuojama kabinti;
 - koks turi būti scenos gylis ir plotis;
 - kur stovės scena;
 - ar reikalinga šalia monitorinė;
 - kokio dydžio turi būti operatorinė;
 - ar reikia minios atitvarų scenos priekyje.



5. Neapkraukite potencialių scenos statymo tiekėjų prašydami pateikti nereikalingus dokumentus, kuriuos nesąžiningi dalyviai tiesiog traukia iš interneto. Paprašykite pateikti tik būtiniausias ir įsitikinkite, kad dokumentai išduoti būtent scenos statymų veikla užsiimančiai bendrovei - scenos brėžinys su nurodytomis galimomis apkrovomis įrangos kabinimui ir gamintojo išduotas scenos techninis pasas - sertifikatas.



6. Siekiant greito ir efektyvaus bendravimo, kartu su pirkimo dokumentais pravartu paprašyti pateikti ir renginį aptarnausiančių specialistų sąrašą su garso operatoriaus, šviesų dailininko, LED ekrano operatoriaus ir projekto vadovo kontaktais.



Recommendations for people organising public procurements



1. The procurement for the rent of stage, LED screen, audio, lighting or similar services must be announced 2 months prior the beginning of event.



2. Do not rewrite, change or try to make technical requirements of the bands or performers similar. It's better to attach all of these requirements as a separate document to the procurement material. In addition to the requirements, we recommend writing that technical characteristics of the proposed equipment must fully comply with technical requirements (riders) of the bands and performers, which are an integral part of this procurement, attached as Annex No 1.



3. By organising a public procurement, request to provide the following:
 - A detailed list of audio equipment by indicating the necessary electric power and weight of equipment, which has to be hung above the stage;
 - A detailed list of lighting equipment by indicating the necessary electric power and weight of equipment, which has to be hung above the stage;
 - The main technical characteristics of the proposed LED screen (dimensions, weight, distance between the pixel centres (P), brightness and the necessary electric power).



You definitely have to ask to indicate the necessary electric power in order to provide such information for electricians in a timely manner (in case of events that are organised outside the arenas, additional electric generators are often needed).



Also it is necessary to ask to indicate the total weight of all the rigged equipment (LED screens, audio equipment and lighting) in order to properly perform the requirements for the procurement of the stage.



4. Organise the procurement of a stage only after the procurement of rental services of all other equipment and after you know the requirements of sound operators, lighting engineers, operators of LED screens and decorators to the stage. Announce the procurement of stage building service only after you have answers to the following questions:
 - What is the height of the stage?
 - What is the weight of equipment that you plan to hang?
 - What is the depth and width of the stage?
 - Where the stage will be located?
 - Do you need a monitor house next to it?
 - What is the necessary size of the FOH?
 - Do you need the crowd barriers in front of the stage?



5. Do not disturb the potential suppliers who can build a stage by asking them to provide the unnecessary documents, which unfair participants will directly download from the internet. Ask them to provide only the most important documents and make sure that these documents were issued by the company, which perform stage building activities - a drawing of a stage with the indicated potential loads for the hung equipment and technical passport - certificate issued by the manufacturer of a stage.



6. To communicate quickly and efficiently, in addition to the procurement documents, it can be practical to ask for a list of specialists, who will provide services during an event, including the contacts of sound operator, lighting technician, operator of a LED screen and project manager.

Laisvės TV

Laisvės TV yra vienintelė Lietuvoje ir viena iš nedaugelio pasaulyje sutelktinio finansavimo būdu išlaikomų televizijų. Partnerių dėka galime savo sąlyginai nedidelei YouTube televizijai leisti tokius sezono renginius, kurių nebeįsigauna net didžiosios įprastinės televizijos. ProDJ yra vieni iš tų partnerių, kuriais galime pasitikėti. Darbas su jais – itin paprastas ir palengvinantis renginio organizavimo procesą.



Laisvės TV

"Laisvės TV" is the only television in Lithuania and one of the many televisions around the world, which is supported by the method of crowdfunding. Due to our partners, we can allow our relatively small "YouTube" television to broadcast such seasonal events, which the usual largest televisions cannot allow to themselves. "ProDJ" is one of those partners, which we can trust. It's easy to work with them because they simplify the process of event organisation."

Krepšinio klubas „Neptūnas“

„Krepšinio klubas „Neptūnas“ ir „ProDJ“ bendradarbiauja nuo 2014 metų, kuomet „Neptūnas“ sužaidė savo pirmąsias varžybas Eurolygoje. Tai puikus verslo ir sporto partnerystės pavyzdys.“

Vyr. Treneris Kazys Maksvytis



Basketball Club "Neptūnas"

"The Basketball Club "Neptūnas" and "ProDJ" cooperate since 2014, when "Neptūnas" played its first match at the EuroLeague. It is a great example of partnership between business and sports."

Chief Coach Kazys Maksvytis

Klaipėdos prekybos, pramonės ir amatų rūmai

ProDJ – jauna, veržli, patikima bendrovė, subūrusi profesionalią, nebijančią sunkumų ir rizikos komandą. Vienas iš bendrovės darbo stiliaus bruožų – jaunatviškas maksimalizmas ir energija, kurie tokiame kūrybą ir techniką jungiančiame versle yra tiesiog būtini. Kartu rengėme didelius ir mažesnius renginius verslui. Manau, kad šiai komandai galima patikėti ir Klaipėdos prekybos, pramonės ir amatų rūmų veiklos 100 metų jubiliejaus rūpesčius.

*Generalinis direktorius
Viktoras Krolis*



Klaipėda Chamber of Commerce, Industry and Crafts

ProDJ is a young, active and reliable company, having a professional team who is not afraid of difficulties and risk. One of the features of their working style is a youthful maximalism and energy, which are essential in a business, uniting creativity with technologies.

Together we prepared large and small business events. I believe that we can entrust them the matters of the 100th anniversary of Klaipėda Chamber of Commerce, Industry and Crafts."

Director General Viktoras Krolis

Heiner
Goebbels
"Stiffers Dinge",
Švyrutio arena,
2017



Klaipėdos koncertų salė

Jau ketverius metus bendradarbiaujame su UAB „ProDJ“ bendrove, kuri sėkmingai įgyvendina techninį renginių aptarnavimą organizuojant Klaipėdos kariliono festivalį. Didžiulis iššūkis bendrovei atiteko 2017 m. įgyvendinant festivalio „Permainų muzika“ vieng iš projektų, tai pasaulinio pripažinimo pelniusio teatro legendos Heinerio Goebbelso instaliaciją-spektaklį „Stiffers Dinge“ („Stiffierio daiktai“). Šio projekto išskirtinumas – itin sudėtingas techninių poreikių išpildymas tiek pasirengimo darbams, tiek ir projekto įgyvendinimo metu. Bendrovės darbuotojai pasižymėjo ypatinga kompetencija komunikuojant su režisieriumi ir technikos direktoriumi dėl sceninės įrangos, apšvietimo, garso technikos bei žiūrovinės erdvės parengimo. Vertiname labai palankiai „ProDJ“ komandos profesionalumą, kompetenciją bei gebėjimą dirbti su tarptautinio lygio komanda įgyvendinti vieng iš sudėtingiausių projektų.

*Danutė Žičkuvienė
Klaipėdos koncertų salės direktorė*



Klaipėda Concert Hall

“We cooperate with UAB “ProDJ” for the fourth year in a row because it successfully implements technical maintenance of events during the organisation of Klaipėda Carillon Festival. In 2017, the company faced a high challenge during the implementation of one of the project belonging to the festival “Music of Changes” – it is a performative

installation of the world-renowned legend of theatre Heiner Goebbels “Stiffers Dinge”. The exclusivity of this project is an extremely complicated fulfilment of technical requirements to the works of preparation and during the implementation of the project. Company’s employees had a special competence in communicating with the director and technical director, regarding the preparation of stage equipment, lighting, sound technologies and area of viewers. We give a favourable consideration to the professionalism and competence of “ProDJ” team, as well as its ability to work with a team of an international level during the implementation of one of the most complicated projects.”

*Danutė Žičkuvienė
Director of Klaipėda Concert Hall*

Jūros šventės organizatorius, “Klaipėdos šventės” direktorius Romandas Žiubrys

“ProDJ” - bendrovė, gavusi pirmąjį rimtą krikštą būtent Jūros šventėje, auganti kartu su kiekvienu nauju projektu, burianti profesionalų technikų kolektyvą, kuris nebijo kūrybinių iššūkių.”



Organiser of “The Sea Festival” and Director of “Klaipėdos šventės” company Romandas Žiubrys

“ProDJ” is a company, which received a first serious “baptism” at “The Sea Festival”, growing together with every new project and gathering a team of professional technicians, which is not afraid of creative challenges.”

ProDJ remia renginius, kuriuos organizuoja / "ProDJ" supports events, which are organised by:

**VŠĮ „Lekiam“, šokių čempionatai
„Lithuanian cup“ ir „Baltic salsa
show cup“**

ProDJ stebina, kaip greitai pradeda naudoti vos ką tik rinkoje pasirodžiusias naujausias technologijas. Mes taip pat esame inovatyvūs, o ProDJ prieš kiekvieną mūsų organizuojamą renginį ateina su vis naujais techniniais sprendimais ir idėjomis. Džiaugiamės, kad jie remia šokių projektus ir puikiai suprantame, kad be jų paramos nepasiektume norimo rezultato.

*Viėšosios įstaigos „Lekiam“
direktorius, šokių čempionatų
„Lithuanian cup“ ir „Baltic
salsa show cup“ organizatorius
Mindaugas Lekauskas*



**The Public Enterprise
"Lekiam", dance championships
"Lithuanian Cup" and "Baltic
Salsa Show Cup"**

It is surprising how fast "ProDJ" begins using the latest technologies, which recently occurred in the market. We are also innovative and "ProDJ" meet us with new technical solutions and ideas before every event organised by us. We are glad that they support dance projects and we fully understand that without their support we would not achieve the desired result.

*Director of the Public Enterprise
"Lekiam" and Organiser of the
dance championships "Lithuanian
Cup" and "Baltic Salsa Show Cup"
Mindaugas Lekauskas*

Vilties bėgimas

Vilties bėgimo akciją įmonė ProDJ remia jau kelis metus. Kartu įgyvendiname idėjas šios akcijos apipavidalinimui bei techniniam išpildymui. Tai patikima, profesionali komanda, su kuria lengva dirbti bei komunikuoti.

*Valdas Daujotas
"Vilties bėgimo" akcijos
koordinatorius*



Campaign "Run for Hope"

"ProDJ" supports the campaign "Run for Hope" for several years in a row. Together we have implemented ideas, related to the style and technical implementation of this campaign. It is a reliable and professional team, with which it is easy to work and communicate."

*Valdas Daujotas
Coordinator of the campaign
"Run for Hope"*

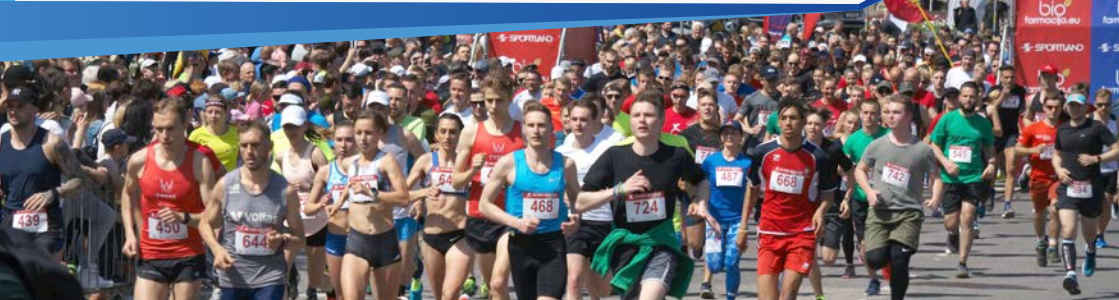

Vaiko širdies asociacija

Su ProDJ komanda dirbame jau daugelį metų ir visada jais galime pasikliauti. Labai esame Jiems dėkingi už pagalbą įgyvendinant Vaiko širdies asociacijos iniciatyvas.

Prezidentė Daiva Jonauskienė



Association of a Child's Heart

"We cooperate with "ProDJ" for many years and we can always trust them. We are very thankful to them for their help during the implementation of initiatives organised by the "Association of a Child's Heart".

President Daiva Jonauskienė



Gatvės krepšinio turnyras 3x3

Ačiū ProDJ įmonei ir jos vadovui Dovydui Bajorui už profesionalų, geranorišką ir kokybišką darbą organizuojant 3x3 gatvės krepšinio turnyrą "Rytas su Time Team". Jūsų techninės galimybės ir darbo kultūra - aukščiausio lygio!

*Organizatorius Laimonas Šapkauskas
Vaikų globos namai „Rytas“*



Street Basketball Tournament 3x3

"We would like to thank "ProDJ" and its manager Dovydas Bajoras for the professional, benevolent and high quality work performed during the organisation of the Street Basketball Tournament 3x3 "Rytas with Time Team". Your technical abilities and work culture was of the highest level!"

Organiser Laimonas Šapkauskas

3x3
RYTAS



Užsienio muzikantai, kurių koncertuose dirbome / Foreign musicians that we worked with

„ProDJ“ nuomojama įranga atitinka aukščiausius užsienio atlikėjų standartus.

„ProDJ“ komanda dirbo renginiuose, kuriuose pasirodė šie atlikėjai:

The equipment rented by ProDJ meets the highest standards of foreign performers.

ProDJ team worked with events where these artists performed.



Patricia
Kaas



Evanescence



Bon
Giovi
Tribute
Band UK



DJ Tigo



Fools
Garden



Maksim
Galkin



Mother
Africa



Stas
Pecha



Broliai
Safronavi



Aleksandr
Reva ir Mikhail
Galustyan



Dima
Bilan



Svetlana
Loboda

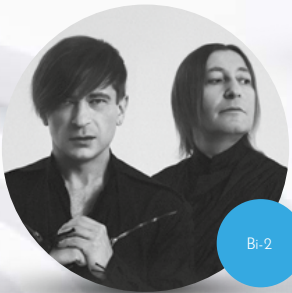

Bi-2



Ljubov
Uspenskaja



Maurice
Bejart Ballet



Timati



ARRIVAL
from
Sweden



Nochnyje
snajper



Stas
Michailov

ir kitais / and others

Lietuvos muzikantai, su kuriais bendradarbiauome / Lithuanian musicians that we worked with

„ProDJ“ komanda pelnė daugumos lietuviškų muzikos grupių ir muzikantų pasitikėjimą.

Įvairiomis progomis ji dirbo su tokiais žymybėmis kaip:

“ProDJ” team has earned trust of most Lithuanian bands and musicians.

It has worked with the following celebrities on various occasions:

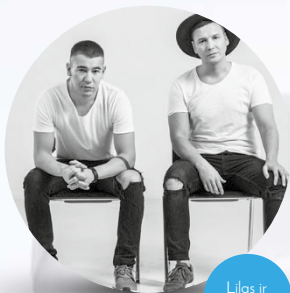
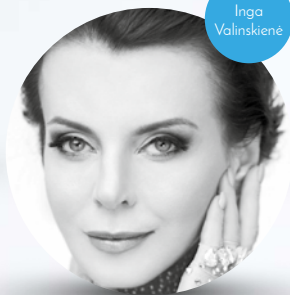



Jurga Šeduikyte



8 Kambarys



Beissoul & Einius



G&G Sindikatas



Biplan



National reed orchestra Trimitas



Bavarija



Rondo

ir kitais /
and others



Dirbame su / We Work With:

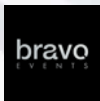

VĮ KLAIPĖDOS VALSTYBINIS
JŪRŲ UOSTO DIREKCIJA



LITHUANIA



Language ... **Lihtuanian**

Other languages spoken:
51 % in English

44 % Russian language

Most Lithuanians speak 2 foreign languages.



Washed Shores ... **Baltic Sea**

Baltic Sea coastline - **90,66 km**

The state is bordered by land borders with:
Latvia, Poland, Belarus and
the Kaliningrad (Russia)



Currency ... **Euro**

The main banks:

SEB, Swedbank, Luminor (Nordea, DnB)



Population ... **2,9 mln**



Government ... **Unitary
parliamentary republic**

EU member since 2004.
NATO member since 2004.



The largest cities ... **Vilnius,
Kaunas, Klaipeda**

67 %
of people live in cities

